

**CHBE320 LECTURE XI
CONTROLLER DESIGN AND PID
CONTROLLER TUNING**

Professor Dae Ryook Yang

Fall 2021

**Dept. of Chemical and Biological Engineering
Korea University**

Road Map of the Lecture XI

- **Controller Design and PID Tuning**
 - Performance criteria
 - Trial and error method
 - Continuous cycling method
 - Relay feedback method
 - Tuning relationships
 - Direct Synthesis
 - Internal Model Control (IMC)
 - Effects of modeling error

CONTROLLER DESIGN

- **Performance criteria for closed-loop systems**
 - **Stable**
 - **Minimal effect of disturbance**
 - **Rapid, smooth response to set point change**
 - **No offset**
 - **No excessive control action**
 - **Robust to plant-model mismatch**

$$\min_{K_C, \tau_I, \tau_D} \int_0^{\infty} (w_1 e^2(\tau) + w_2 \Delta u^2(\tau)) d\tau$$

- **Trade-offs in control problems**
 - **Set point tracking vs. disturbance rejection**
 - **Robustness vs. performance**

GUIDELINES FOR COMMON CONTROL LOOPS

- **Flow and liquid pressure control**

- Fast response with no time delay
- Usually with small high-frequency noise
- PI controller with intermediate controller gain
 - $0.5 < K_c < 0.7$ and $0.2 < \tau_I < 0.3 \text{min}$ (Fruehauf et al. (1994))

- **Liquid level control**

- Noisy due to splashing and turbulence
- High gain PI controller for integrating process
 - Increase in K_c may decrease oscillation (special behavior)
- Conservative setting for averaging control when it is used for damping the fluctuation of the inlet stream (usually P-control)

- **PI control:**

$$K_c = 100\%/\Delta h, \quad \tau_I = 4V/(K_c Q_{max}) \quad (\Delta h \equiv \min(h_{max} - h_{sp}, h_{sp} - h_{min}))$$

- **Error-squared controller with careful tuning**

- **If heat transfer is involved, it becomes much more complicated.**

- **Gas pressure control**
 - Usually fast and self regulating
 - PI controller with small integral action (large reset time)
 - D mode is not usually needed.
- **Temperature control**
 - Wide variety of the process nature
 - Usually slow response with time delay
 - Use PID controller to speed up the response
- **Composition control**
 - Similar to temperature control usually with larger noise and more time delay
 - Effectiveness of derivative action is limited
 - Temperature and composition controls are the prime candidates for advance control strategies due to its importance and difficulty of control

TRIAL AND ERROR TUNING

- **Step1: With P-only controller**

- Start with low K_c value and increase it until the response has a sustained oscillation (continuous cycling) for a small set point or load change. (K_{cu})
- Set $K_c = 0.5K_{cu}$.

- **Step2: Add I mode**

- Decrease the reset time until sustained oscillation occurs. (τ_{Iu})
- Set $\tau_I = 3\tau_{Iu}$.
- If a further improvement is required, proceed to Step 3.

- **Step3: Add D mode**

- Increase the preact time until sustained oscillation occurs. (τ_{Du})
- Set $\tau_D = \tau_{Du}/3$.

(The sustained oscillation should not be cause by the controller saturation)

CONTINUOUS CYCLING METHOD

- **Also called as loop tuning or ultimate gain method**
 - Increase controller gain until sustained oscillation
 - Find ultimate gain (K_{CU}) and ultimate period (P_{CU})
- **Ziegler-Nichols controller setting**
 - $1/4$ decay ratio (too much oscillatory)

Controller	K_C	τ_I	τ_D
P	$0.5K_{CU}$	-	-
PI	$0.45K_{CU}$	$P_{CU}/1.2$	-
PID	$0.6K_{CU}$	$P_{CU}/2$	$P_{CU}/8$

- **Modified Ziegler-Nichols setting**

Controller	K_C	τ_I	τ_D
Original	$0.6K_{CU}$	$P_{CU}/2$	$P_{CU}/8$
Some overshoot	$0.33K_{CU}$	$P_{CU}/2$	$P_{CU}/3$
No overshoot	$0.2K_{CU}$	$P_{CU}/2$	$P_{CU}/3$

• Examples

$$G_p(s) = \frac{4e^{-3.5s}}{7s + 1}$$

$$K_{CU} = 0.95$$

$$P_{CU} = 12$$

$$G_p(s) = \frac{2e^{-s}}{(10s + 1)(5s + 1)}$$

$$K_{CU} = 7.88$$

$$P_{CU} = 11.6$$

Controller	K_C	τ_I	τ_D
Original	0.57	6.0	1.5
Some overshoot	0.31	6.0	4.0
No overshoot	0.19	6.0	4.0

Controller	K_C	τ_I	τ_D
Original	4.73	5.8	1.45
Some overshoot	2.60	5.8	3.87
No overshoot	1.58	5.8	3.87

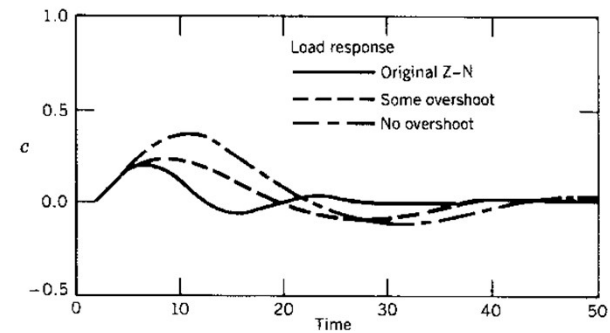
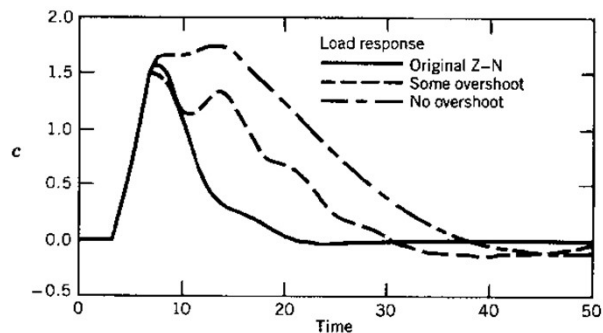
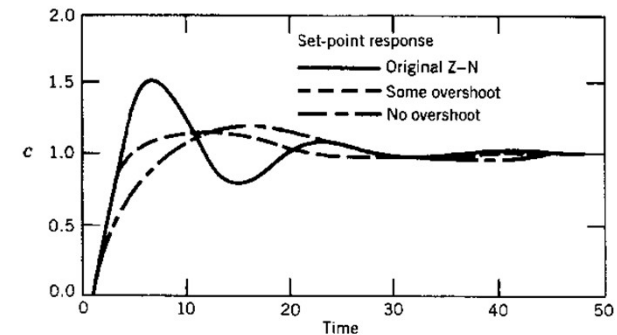
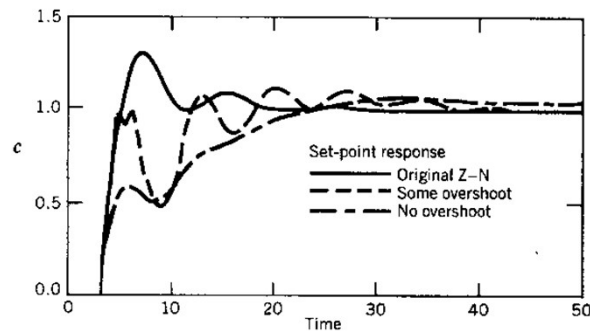

- **Advantages of continuous cycling method**
 - No a priori information on process required
 - Applicable to all stable processes
 - **Disadvantages of continuous cycling method**
 - Time consuming
 - Loss of product quality and productivity during the tests
 - Continuous cycling may cause the violation of process limitation and safety hazards
 - Not applicable to open-loop unstable process
 - First-order and second-order process without time delay will not oscillate even with very large controller gain
- => Motivates Relay feedback method. (Astrom and Wittenmark)**

RELAY FEEDBACK METHOD

- **Relay feedback controller**

- Forces the system to oscillate by a relay controller
- Require a single closed-loop experiment to find the ultimate frequency information
- No *a priori* information on process is required
- Switch relay feedback controller for tuning
- Find P_{CU} and calculate K_{CU}

$$K_{CU} = \frac{4d}{\pi a}$$

- **User specified parameter: d**

Decide d in order not to perturb the system too much.

- Use Ziegler-Nichols Tuning rules for PID tuning parameters

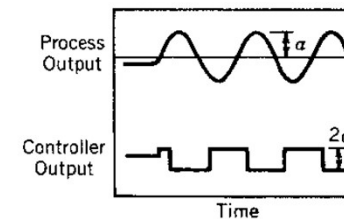
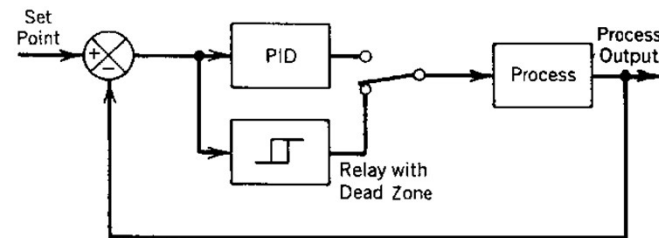

- **Calculation of model parameters from K_{CU} and P_U**

- **Integrator-plus-time-delay model:** $G(s) = \frac{K e^{-\theta s}}{s}$

$$K = \frac{2\pi}{K_{CU} P_U} \quad \theta = P_U/4$$

- **First-order-plus-time-delay model:** $G(s) = \frac{K e^{-\theta s}}{\tau s + 1}$

$$K = \frac{2\pi}{K_{CU} P_U}$$

$$\tau = \frac{P_U}{2\pi} \tan \frac{\pi(P_U - 2\theta)}{P_U} \quad \text{or} \quad \tau = \frac{P_U}{2\pi} \sqrt{(K K_{CU})^2 - 1}$$

- **The θ is decided by visual inspection and K can be calculated using two equations of τ above.**

DESIGN RELATIONS FOR PID CONTROLLERS

- **Cohen-Coon controller design relations**
 - Empirical relation for 1/4 decay ratio for FOPDT model

Table 12.2 Cohen and Coon Controller Design Relations

<i>Controller</i>	<i>Settings</i>	<i>Cohen-Coon</i>
P	K_c	$\frac{1}{K} \frac{\tau}{\theta} [1 + \theta/3\tau]$
PI	K_c	$\frac{1}{K} \frac{\tau}{\theta} [0.9 + \theta/12\tau]$
	τ_I	$\frac{\theta[30 + 3(\theta/\tau)]}{9 + 20(\theta/\tau)}$
PID	K_c	$\frac{1}{K} \frac{\tau}{\theta} \left[\frac{16\tau + 3\theta}{12\tau} \right]$
	τ_I	$\frac{\theta[32 + 6(\theta/\tau)]}{13 + 8(\theta/\tau)}$
	τ_D	$\frac{4\theta}{11 + 2(\theta/\tau)}$

- **Design relations based on integral error criteria**

- 1/4 decay ratio is too oscillatory
- Decay ratio concerns only two peak points of the response
- **IAE: Integral of the Absolute Error**

$$\text{IAE} = \int_0^{\infty} |e(t)| dt$$

- **ISE: Integral of the Square Error**

$$\text{ISE} = \int_0^{\infty} [e(t)]^2 dt$$

- Large error contributes more
- Small error contributes less
- Large penalty for large overshoot
- Small penalty for small persisting oscillation

- **ITAE: Integral of the Time-weighted Absolute Error**

$$\text{ITAE} = \int_0^{\infty} t |e(t)| dt$$

- Large penalty for persisting oscillation
- Small penalty for initial transient response

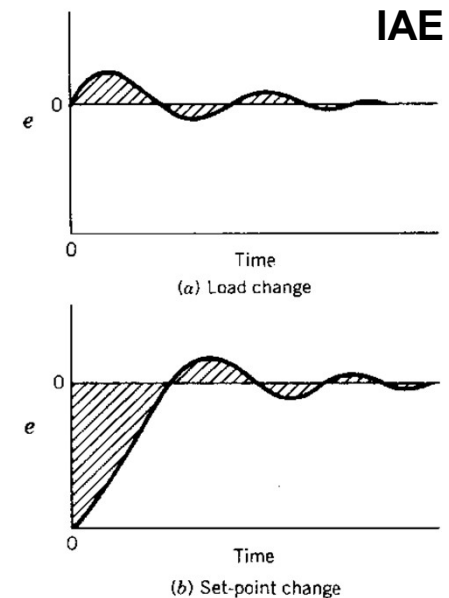

- **Controller design relation based on ITAE for FOPDT model**

Table 12.3 Controller Design Relations Based on the ITAE Performance Index and a First-Order plus Time-Delay Model [6–8]^a

<i>Type of Input</i>	<i>Type of Controller</i>	<i>Mode</i>	<i>A</i>	<i>B</i>
Load	PI	P	0.859	−0.977
		I	0.674	−0.680
Load	PID	P	1.357	−0.947
		I	0.842	−0.738
		D	0.381	0.995
Set point	PI	P	0.586	−0.916
		I	1.03 ^b	−0.165 ^b
Set point	PID	P	0.965	−0.85
		I	0.796 ^b	−0.1465 ^b
		D	0.308	0.929

^aDesign relation: $Y = A(\theta/\tau)^B$ where $Y = KK_c$ for the proportional mode, τ/τ_I for the integral mode, and τ_D/τ for the derivative mode.

^bFor set-point changes, the design relation for the integral mode is $\tau/\tau_I = A + B(\theta/\tau)$. [8]

- **Similar design relations based on IAE and ISE for other types of models can be found in literatures.**

Example 1

$$G(s) = \frac{10e^{-s}}{2s + 1}$$

$$KK_c = (0.859)(1/2)^{-0.977} = 1.69$$

$$\Rightarrow K_c = 0.169$$

$$\tau/\tau_I = (0.674)(1/2)^{-0.680} = 1.08$$

$$\Rightarrow \tau_I = 1.85$$

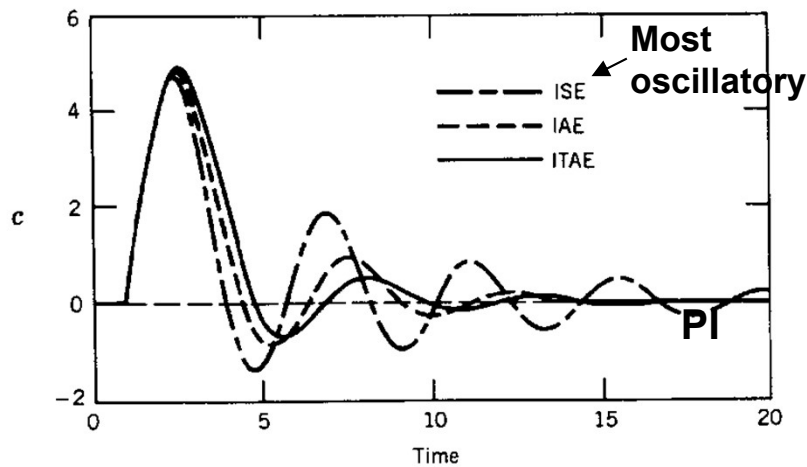

Method	K_c	τ_I
IAE	0.195	2.02
ISE	0.245	2.44
ITAE	0.169	1.85

Example 2

$$G(s) = \frac{4e^{-3.5s}}{7s + 1}$$

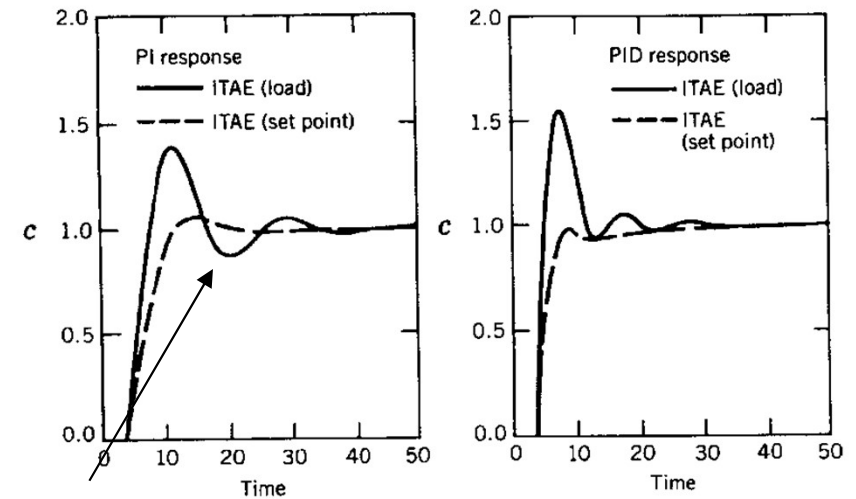

Trade-offs

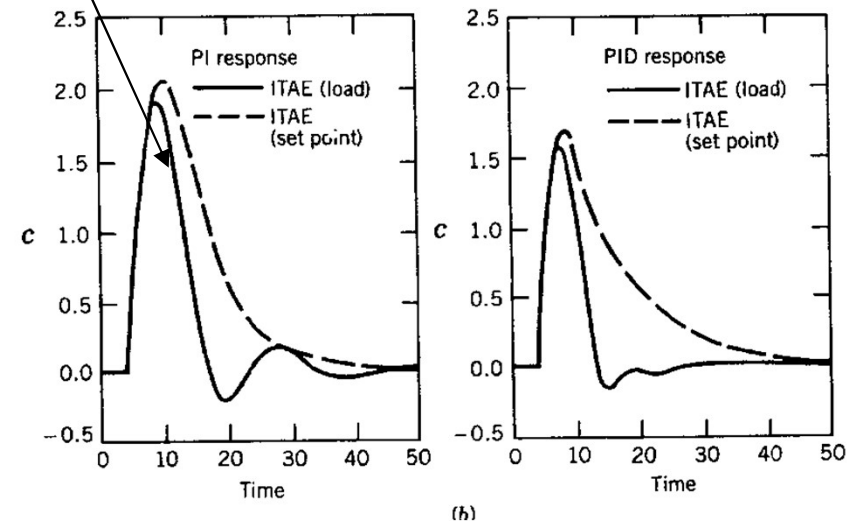

- **Design relations based on process reaction curve**
 - For the processes who have sigmoidal shape step responses
(Not for underdamped processes)
 - Fit the curve with FOPDT model

$$G(s) = \frac{K e^{-\theta}}{(\tau s + 1)} \quad S = K\Delta u/\tau \quad S^* = S/\Delta u = K/\tau$$

Table 13.3 Ziegler–Nichols Tuning Relations (Process Reaction Curve Method)

<i>Controller Type</i>	K_c	τ_I	τ_D
P	$\frac{1}{\theta S^*}$	—	—
PI	$\frac{0.9}{\theta S^*}$	3.33 θ	—
PID	$\frac{1.2}{\theta S^*}$	2 θ	0.5 θ

- Very simple
- Inherits all the problems of FOPDT model fitting

MISCELLANEOUS TUNING RELATIONS

- **Hägglund and Åström (2002)**

Table 12.4 PI Controller Settings:
Hägglund and Åström (2002)

$G(s)$	K_c	τ_I
$\frac{Ke^{-\theta s}}{s}$	$\frac{0.35}{K\theta}$	7θ
$\frac{Ke^{-\theta s}}{\tau s + 1}$	$\frac{0.14}{K} + \frac{0.28\tau}{\theta K}$	$0.33\theta + \frac{6.8\theta\tau}{10\theta + \tau}$

- **Skogestad (2003)**

Table 12.5 Controller Settings for $G(s) = Ke^{-\theta s}/(\tau_1 s + 1)(\tau_2 s + 1)$:
Skogestad (2003)

Conditions	K_c	τ_I	τ_D
$\tau_1 \leq 8\theta$	$\frac{0.5(\tau_1 + \tau_2)}{K\theta}$	$\tau_1 + \tau_2$	$\frac{\tau_1\tau_2}{\tau_1 + \tau_2}$
$\tau_1 \geq 8\theta$	$\frac{0.5\tau_1}{K\theta} \left(\frac{8\theta + \tau_2}{8\theta} \right)$	$8\theta + \tau_2$	$\frac{8\theta\tau_2}{8\theta + \tau_2}$

- **Ziegler-Nichols (1942) and Cohen-Coon (1953) are not recommended since their relations are base on 1/4-decay ratio.**

CONTROLLERS WITH TWO DEGREES OF FREEDOM

- Trade-off between set-point tracking and disturbance rejection
- Tuning for disturbance rejection is more aggressive.
- In general, disturbance rejection is more important. Thus, tune the controller for satisfactory disturbance rejection.
- **Controllers with two degrees of freedom (Goodwin et al., 2001)**
 - Strategies to adjust set-point tracking and disturbance rejection independently

1. Gradual change in set point (ramp or filtered)

$$\frac{Y_{sp}^*}{Y_{sp}} = \frac{1}{\tau_f s + 1} \quad (\text{filtered as first order})$$

2. Modification of PID control law

$$p(t) = \bar{p} + K_c(\beta y_{sp} - y_m) + K_c \left(\frac{1}{\tau_I} \int_0^t e(t^*) dt^* - \tau_D \frac{dy_m}{dt} \right) \quad (0 < \beta < 1)$$

- As β increase, the set-point response becomes faster but more overshoot.

DIRECT SYNTHESIS METHOD

- **Analysis: Given $G_c(s)$, what is $y(t)$?**
- **Design: Given $y_d(t)$, what should $G_c(s)$ be?**
- **Derivation**

$$\text{Let } G_{OL} = K_m G_c G_v G_p \triangleq G_c G$$

$$\frac{Y(s)}{R(s)} = \frac{G_{OL}}{1 + G_{OL}} = \frac{G_c G}{1 + G_c G} \Rightarrow G_c = \frac{1}{G} \left(\frac{Y/R}{1 - Y/R} \right)$$

$$\text{Specify } (Y/R)_d \Rightarrow G_c = \frac{1}{G} \left(\frac{(Y/R)_d}{1 - (Y/R)_d} \right)$$

- **If $(Y/R)_d = 1$, then it implies perfect control. (infinite gain)**
- **The resulting controller may not be physically realizable**
- **Or, not in PID form and too complicated.**
- **Design with finite settling time:** $(Y/R)_d = \frac{1}{\tau_c s + 1}$

- **Examples**

- 1. Perfect control (K_c becomes infinite)**

$$G(s) = \frac{K}{(\tau_1 s + 1)(\tau_2 s + 1)} \text{ and } (Y/R)_d = 1$$

$$G_c(s) = \frac{1}{G(s)} \left(\frac{1}{1-1} \right) = \frac{\infty}{G(s)} \text{ (infinite gain, unrealizable)}$$

- 2. Finite settling time for 1st-order process**

$$G(s) = \frac{K}{(\tau s + 1)} \text{ and } (Y/R)_d = \frac{1}{\tau_c s + 1}$$

$$G_c(s) = \frac{1}{G(s)} \left(\frac{1/(\tau_c s + 1)}{1 - 1/(\tau_c s + 1)} \right) = \frac{\tau s + 1}{K \tau_c s} = \frac{\tau}{\tau_c K} \left(1 + \frac{1}{\tau s} \right) \text{ (PI)}$$

- 3. Finite settling time for 2nd-order process**

$$G(s) = \frac{K}{(\tau_1 s + 1)(\tau_2 s + 1)} \text{ and } (Y/R)_d = \frac{1}{\tau_c s + 1}$$

$$G_c(s) = \frac{(\tau_1 + \tau_2)}{\tau_c K} \left(1 + \frac{1}{(\tau_1 + \tau_2)s} + \frac{\tau_1 \tau_2}{(\tau_1 + \tau_2)} s \right) \text{ (PID)}$$

- **Process with time delay**

- If there is a time delay, any physically realizable controller cannot overcome the time delay. (Need time lead)
- Given circumstance, a reasonable choice will be

$$(Y/R)_d = \frac{e^{-\theta_c s}}{\tau_c s + 1}$$

- **Examples**

1. $G(s) = \frac{K e^{-\theta s}}{(\tau s + 1)}$ and $(Y/R)_d = \frac{e^{-\theta s}}{\tau_c s + 1}$ ($\theta_c = \theta$)

$$G_c(s) = \frac{1}{G(s)} \left(\frac{e^{-\theta} / (\tau_c s + 1)}{1 - e^{-\theta s} / (\tau_c s + 1)} \right) = \frac{\tau s + 1}{K} \boxed{\frac{1}{\tau_c s + 1 - e^{-\theta s}}} \text{ (not a PID)}$$

Physically unrealizable

2. **With 1st-order Taylor series approx.** ($e^{-\theta s} \approx 1 - \theta s$)

$$G_c(s) = \frac{\tau s + 1}{K} \frac{1}{(\tau_c + \theta)s} = \frac{\tau}{K(\tau_c + \theta)} \left(1 + \frac{1}{\tau s} \right) \text{ (PI)}$$

3. $G(s) = \frac{K e^{-\theta s}}{(\tau_1 s + 1)(\tau_2 s + 1)}$ and $(Y/R)_d = \frac{e^{-\theta s}}{\tau_c s + 1}$ ($\theta_c = \theta$)

$$G_c(s) = \frac{(\tau_1 s + 1)(\tau_2 s + 1)}{K} \frac{1}{(\tau_c + \theta)s} = \frac{(\tau_1 + \tau_2)}{K(\tau_c + \theta)} \left(1 + \frac{1}{(\tau_1 + \tau_2)s} + \frac{\tau_1 \tau_2}{(\tau_1 + \tau_2)s^2} \right) \text{ (PID)}$$

- **Observations on Direct Synthesis Method**

- Resulting controllers could be quite complex and may not even be physically realizable.
- PID parameters will be decided by a user-specified parameter: The desired closed-loop time constant (τ_c)
- The shorter τ_c makes the action more aggressive. (larger K_c)
- The longer τ_c makes the action more conservative. (smaller K_c)
- For a limited cases, it results PID form.

- 1st-order model without time delay: PI
- FOPDT with 1st-order Taylor series approx.: PI
- 2nd-order model without time delay: PID
- SOPDT with 1st-order Taylor series approx.: PID
- Delay modifies the K_c .

$$\frac{\tau}{K\tau_c} \rightarrow \frac{\tau}{K(\tau_c + \theta)} \quad (1\text{st order})$$

$$\frac{(\tau_1 + \tau_2)}{K\tau_c} \rightarrow \frac{(\tau_1 + \tau_2)}{K(\tau_c + \theta)} \quad (2\text{nd order})$$

- With time delay, the K_c will not become infinite even for the perfect control ($Y/R=1$).

INTERNAL MODEL CONTROL (IMC)

- **Motivation**

- The resulting controller from direct synthesis method may not be physically unrealizable.
- If there is RHP zero in the process, the resulting controller from direct synthesis method will be unstable.
- Unmeasured disturbance and modeling error are not considered in direct synthesis method.

- **Source of trouble**

- From direct synthesis method

$$G_c = \frac{1}{G} \left(\frac{(Y/R)_d}{1 - (Y/R)_d} \right)$$

Resulting controller may have higher-order numerator than denominator

Direct inversion of process causes many problems

Process is unknown

- **IMC**

- **Feedback the error between the process output and model output.**

- **Equivalent conventional controller:**

$$G_c = \frac{G_c^*}{1 - G_c^* \tilde{G}}$$

- **Using block diagram algebra**

$$C = GP + L \quad P = G_c^* E \quad E = R - (C - \tilde{C}) = R - C + \tilde{G}P$$

$$P = G_c^* (R - C + \tilde{G}P)$$

$$\Rightarrow P = G_c^* (R - C) / (1 - G_c^* \tilde{G})$$

$$C = GG_c^* (R - C) / (1 - G_c^* \tilde{G}) + L$$

$$(1 + GG_c^* - G_c^* \tilde{G})C = GG_c^* R + (1 - G_c^* \tilde{G})L$$

$$C = \frac{G_c^* G}{1 + G_c^* (G - \tilde{G})} R + \frac{(1 - G_c^* \tilde{G})}{1 + G_c^* (G - \tilde{G})} L$$

$$\text{If } \tilde{G} = G, C = G_c^* GR + (1 - G_c^* G)L$$

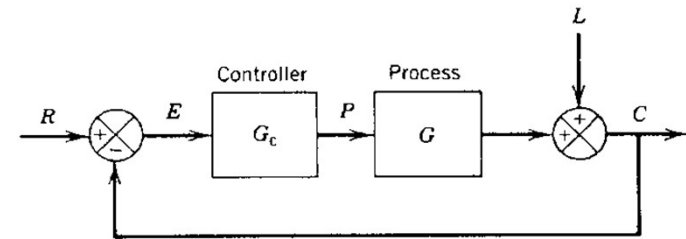

(a) Classical feedback control

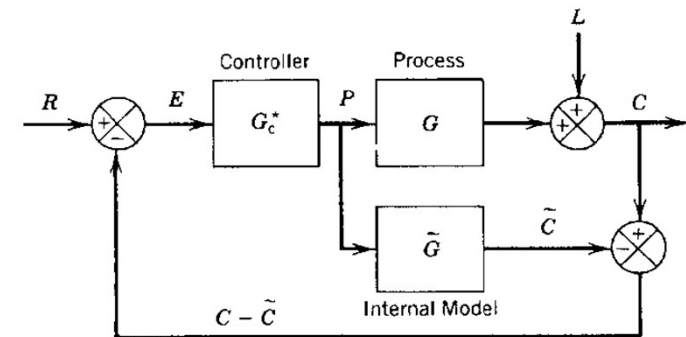

(b) Internal Model Control

- **IMC design strategy**

- Factor the process model as

$$\tilde{G} = \tilde{G}_+ \tilde{G}_-$$

← Uninvertibles

- \tilde{G}_+ contains any time delays and RHP zeros and is specified so that the steady-state gain is one
- \tilde{G}_- is the rest of G .

- The controller is specified as

$$G_c^* = \frac{1}{\tilde{G}_-} f$$

- IMC filter f is a low-pass filter with steady-state gain of one
- Typical IMC filter:

$$f = \frac{1}{(\tau_c s + 1)^r}$$

- The τ_c is the desired closed-loop time constant and parameter r is a positive integer that is selected so that the order of numerator of G_c^* is same as the order of denominator or exceeds the order of denominator by one.

- **Example**

- **FOPDT model with 1/1 Pade approximation**

$$\tilde{G} = \frac{K(1 - \theta s/2)}{(1 + \theta s/2)(\tau s + 1)}$$

$$\tilde{G}_+ = 1 - \theta s/2 \quad \tilde{G}_- = \frac{K}{(1 + \theta s/2)(\tau s + 1)}$$

$$G_c^* = \frac{1}{\tilde{G}_-} f = \frac{(1 + \theta s/2)(\tau s + 1)}{K} \frac{1}{(\tau_c s + 1)}$$

$$G_c = \frac{G_c^*}{1 - G_c^* \tilde{G}} = \frac{(1 + \theta s/2)(\tau s + 1)}{K(\tau_c + \theta/2)s} \quad (\text{PID})$$

$$K_c = \frac{1}{K} \frac{(\tau + \theta/2)}{(\tau_c + \theta/2)} \quad \tau_I = \tau + \theta/2 \quad \tau_D = \frac{\tau\theta/2}{\tau + \theta/2}$$

IMC based PID controller settings

Table 12.1 IMC-Based PID Controller Settings for $G_c(s)$ [4]^a

<i>Case</i>	<i>Model</i>	$K_c K$	τ_I	τ_D
A	$\frac{K}{\tau s + 1}$	$\frac{\tau}{\tau_c}$	τ	—
B	$\frac{K}{(\tau_1 s + 1)(\tau_2 s + 1)}$	$\frac{\tau_1 + \tau_2}{\tau_c}$	$\tau_1 + \tau_2$	$\frac{\tau_1 \tau_2}{\tau_1 + \tau_2}$
C	$\frac{K}{\tau^2 s^2 + 2\zeta\tau s + 1}$	$\frac{2\zeta\tau}{\tau_c}$	$2\zeta\tau$	$\frac{\tau}{2\zeta}$
D	$\frac{K(-\beta s + 1)}{\tau^2 s^2 + 2\zeta\tau s + 1}, \beta > 0$	$\frac{2\zeta\tau}{\tau_c + \beta}$	$2\zeta\tau$	$\frac{\tau}{2\zeta}$
E	$\frac{K}{s}$	$\frac{1}{\tau_c}$	—	—
F	$\frac{K}{s(\tau s + 1)}$	$\frac{1}{\tau_c}$	—	τ

^aBased on Eq. 12-30 with $r = 1$.

IMC based PID controller settings

Table 12.1 IMC-Based PID Controller Settings for $G_c(s)$ (Chien and Fruehauf, 1990)

Case	Model	$K_c K$	τ_I	τ_D
A	$\frac{K}{\tau s + 1}$	$\frac{\tau}{\tau_c}$	τ	—
B	$\frac{K}{(\tau_1 s + 1)(\tau_2 s + 1)}$	$\frac{\tau_1 + \tau_2}{\tau_c}$	$\tau_1 + \tau_2$	$\frac{\tau_1 \tau_2}{\tau_1 + \tau_2}$
C	$\frac{K}{\tau^2 s^2 + 2\zeta \tau s + 1}$	$\frac{2\zeta \tau}{\tau_c}$	$2\zeta \tau$	$\frac{\tau}{2\zeta}$
D	$\frac{K(-\beta s + 1)}{\tau^2 s^2 + 2\zeta \tau s + 1}, \beta > 0$	$\frac{2\zeta \tau}{\tau_c + \beta}$	$2\zeta \tau$	$\frac{\tau}{2\zeta}$
E	$\frac{K}{s}$	$\frac{2}{\tau_c}$	$2\tau_c$	—
F	$\frac{K}{s(\tau s + 1)}$	$\frac{2\tau_c + \tau}{\tau_c^2}$	$2\tau_c + \tau$	$\frac{2\tau_c \tau}{2\tau_c + \tau}$
G	$\frac{K e^{-\theta s}}{\tau s + 1}$	$\frac{\tau}{\tau_c + \theta}$	τ	—
H	$\frac{K e^{-\theta s}}{\tau s + 1}$	$\frac{\tau + \frac{\theta}{2}}{\tau_c + \frac{\theta}{2}}$	$\tau + \frac{\theta}{2}$	$\frac{\tau \theta}{2\tau + \theta}$
I	$\frac{K(\tau_3 s + 1)e^{-\theta s}}{(\tau_1 s + 1)(\tau_2 s + 1)}$	$\frac{\tau_1 + \tau_2 - \tau_3}{\tau_c + \theta}$	$\tau_1 + \tau_2 - \tau_3$	$\frac{\tau_1 \tau_2 - (\tau_1 + \tau_2 - \tau_3)\tau_3}{\tau_1 + \tau_2 - \tau_3}$
J	$\frac{K(\tau_3 s + 1)e^{-\theta s}}{\tau^2 s^2 + 2\zeta \tau s + 1}$	$\frac{2\zeta \tau - \tau_3}{\tau_c + \theta}$	$2\zeta \tau - \tau_3$	$\frac{\tau^2 - (2\zeta \tau - \tau_3)\tau_3}{2\zeta \tau - \tau_3}$
K	$\frac{K(-\tau_3 s + 1)e^{-\theta s}}{(\tau_1 s + 1)(\tau_2 s + 1)}$	$\frac{\tau_1 + \tau_2 + \frac{\tau_3 \theta}{\tau_c + \tau_3 + \theta}}{\tau_c + \tau_3 + \theta}$	$\tau_1 + \tau_2 + \frac{\tau_3 \theta}{\tau_c + \tau_3 + \theta}$	$\frac{\tau_3 \theta}{\tau_c + \tau_3 + \theta} + \frac{\tau_1 \tau_2}{\tau_1 + \tau_2 + \frac{\tau_3 \theta}{\tau_c + \tau_3 + \theta}}$
L	$\frac{K(-\tau_3 s + 1)e^{-\theta s}}{\tau^2 s^2 + 2\zeta \tau s + 1}$	$\frac{2\zeta \tau + \frac{\tau_3 \theta}{\tau_c + \tau_3 + \theta}}{\tau_c + \tau_3 + \theta}$	$2\zeta \tau + \frac{\tau_3 \theta}{\tau_c + \tau_3 + \theta}$	$\frac{\tau_3 \theta}{\tau_c + \tau_3 + \theta} + \frac{\tau^2}{2\zeta \tau + \frac{\tau_3 \theta}{\tau_c + \tau_3 + \theta}}$
M	$\frac{K e^{-\theta s}}{s}$	$\frac{2\tau_c + \theta}{(\tau_c + \theta)^2}$	$2\tau_c + \theta$	—
N	$\frac{K e^{-\theta s}}{s}$	$\frac{2\tau_c + \theta}{\left(\tau_c + \frac{\theta}{2}\right)^2}$	$2\tau_c + \theta$	$\frac{\tau_c \theta + \frac{\theta^2}{4}}{2\tau_c + \theta}$
O	$\frac{K e^{-\theta s}}{s(\tau s + 1)}$	$\frac{2\tau_c + \tau + \theta}{(\tau_c + \theta)^2}$	$2\tau_c + \tau + \theta$	$\frac{(2\tau_c + \theta)\tau}{2\tau_c + \tau + \theta}$

- **Modification of IMC and DS methods**

- For lag dominant models ($\theta/\tau \ll 1$), IMC and DS methods provide satisfactory set-point response, but very slow disturbance responses because the value τ_I is very large.
- Approximate the FOPDT with IPDT model and use IMC tuning relation for IPDT model

$$G(s) = \frac{K e^{-\theta s}}{\tau s + 1} \Rightarrow G(s) = \frac{K^* e^{-\theta s}}{s} \quad \text{where } K^* \triangleq K/\tau$$

- Limit the value of τ_I

$$\tau_I = \min\{\tau_I, 4(\tau_c + \theta)\}$$

- Design the controller for disturbance rejection

COMPARISON OF CONTROLLER DESIGN RELATIONS

- PI controller settings for different methods

$$G(s) = \frac{2e^{-s}}{s + 1}$$

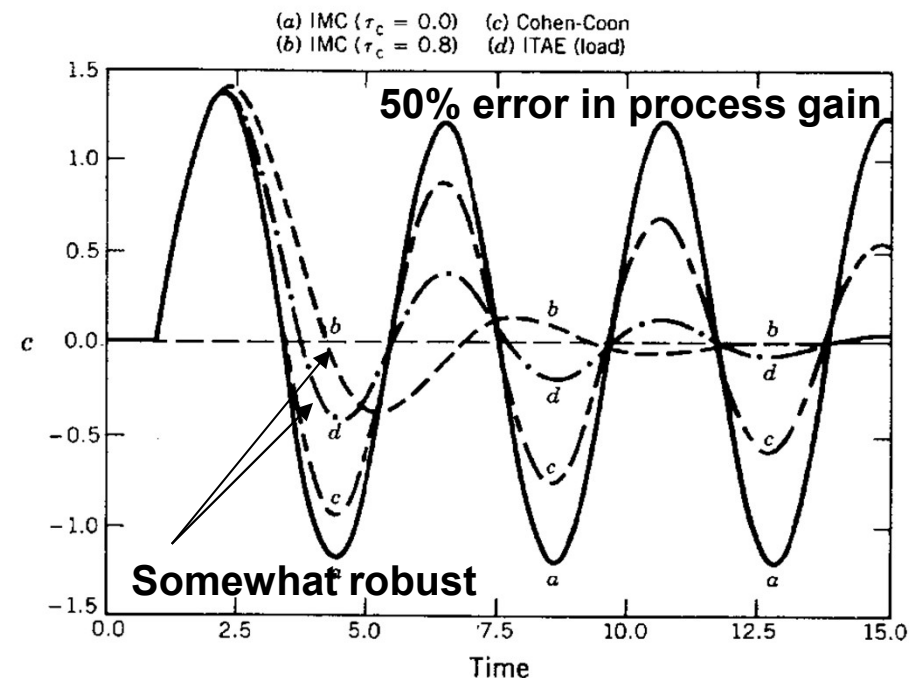
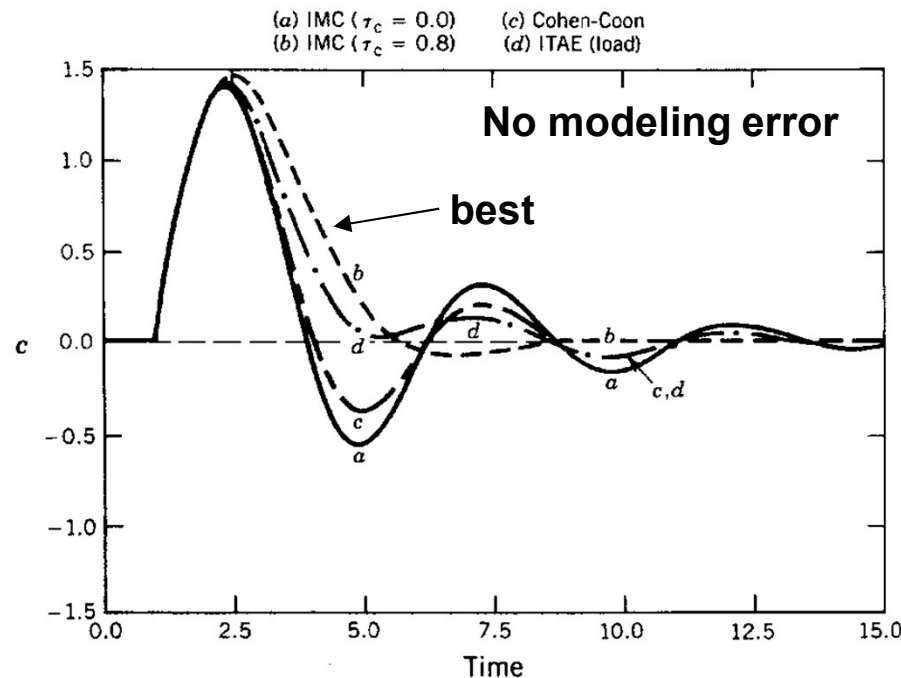

EFFECT OF MODELING ERROR

- **Actual plant**

$$G(s) = \frac{2e^{-s}}{(10s + 1)(5s + 1)}$$

- **Approx. model**

$$\tilde{G}(s) = \frac{2e^{-4.7s}}{12s + 1}$$

- Satisfactory for this case
- Use with care

As the estimated time delay gets smaller, the performance degradation will be pronounced.

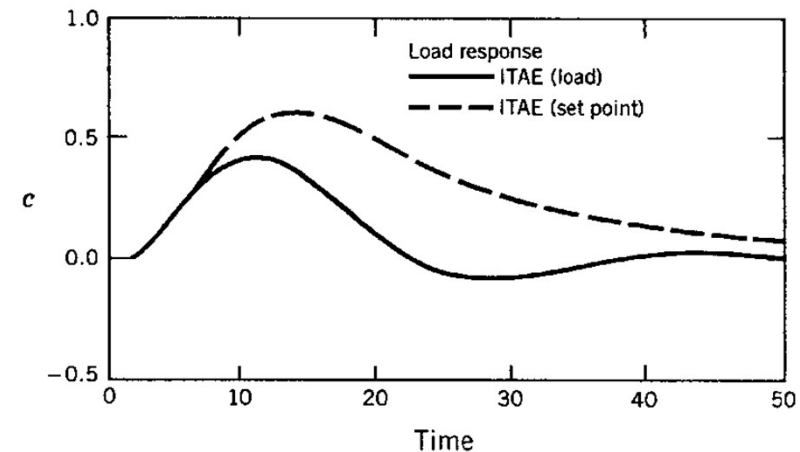
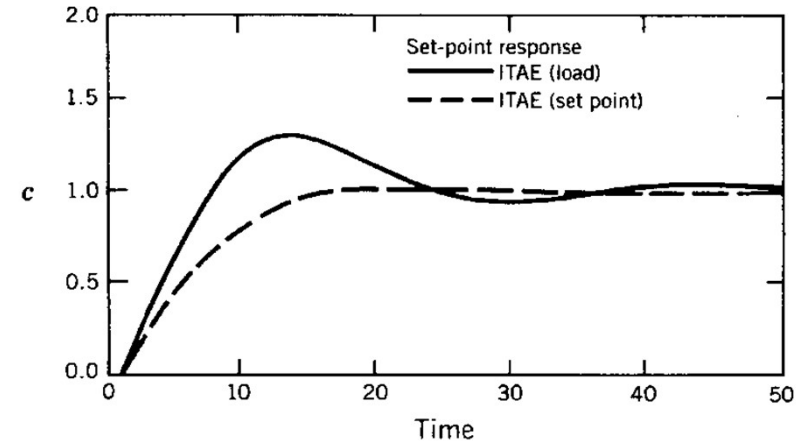

- **All kinds of tuning method should be used for initial setting and fine tuning should be done!!**

GENERAL CONCLUSION FOR PID TUNING

- The controller gain should be inversely proportional to the products of the other gains in the feedback loop.
- The controller gain should decrease as the ratio of time delay to dominant time constant increases.
- The larger the ratio of time delay to dominant time constant is, the harder the system is to control.
- The reset time and the derivative time should increase as the ratio of time delay to dominant time constant increases.
- The ratio between derivative time and reset time is typically between 0.1 to 0.3.
- The $\frac{1}{4}$ decay ratio is too oscillatory for process control. If less oscillatory response is desired, the controller gain should decrease and reset time should increase.
- Among IAE, ISE and ITAE, ITAE is the most conservative and ISE is the least conservative setting.

TROUBLESHOOTING CONTROL LOOPS

- **Causes of performance degradation of controller**
 - Changing process conditions, usually throughput rate
 - Sticking control valve stem
 - Plugged line in a pressure or DP transmitter
 - Fouled heat exchangers, especially reboilers for distillation
 - Cavitating pumps

- **Starting points of trouble shooting**
 - What is the process being controlled?
 - What is the controlled variable?
 - What are the control objectives?
 - Are closed-loop response data available?
 - Is the controller in the M/A mode? Is it reverse or direct acting?
 - If the pressure is cycling, what is the cycling frequency?
 - What control algorithm is used? What are the controller settings?
 - Is the process open-loop stable?
 - What additional documentation is available?

- **Checking points**

- **Components in the control loop (process, sensor, actuator, ...)**

- **Field instruments vs. instruments in central control room**
 - **Recent changes to the equipment or instrumentation (cleaning HX, catalyst replacement, transmitter span, ...)**
 - **Sensor lines (particles, bubbles)**
 - **Control valve sticking**
 - **Controller tuning parameters**