

CHBE320 LECTURE II MEASUREMENT, TRANSMITTERS AND FILTERING

Professor Dae Ryook Yang
Fall 2021
Dept. of Chemical and Biological Engineering
Korea University

CHBE320 Process Dynamics and Control

Korea University 2-1

Road Map of the Lecture II

• Visit Sensor Block

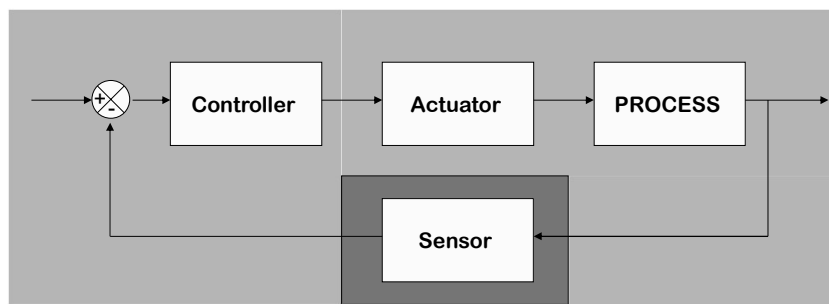

- Kind of sensors
- Principles of the sensors
- Selection of sensors
- Noise filter

CHBE320 Process Dynamics and Control

Korea University 2-2

INTRODUCTION TO SENSOR

- **What is Sensor?**
 - Sensor converts the physical quantity to signal that can be recognized by other components such as display, transmitter and etc.



- **Sensor types**
 - Temperature: thermocouple, RTD, thermistor
 - Pressure: bellows, bourdon tube, diaphragm
 - Flow rate: orifice, venturi, magnetic, ultrasonic, Colioli effect
 - Liquid level: float, differential pressure
 - pH: pH electrode
 - Viscosity: pressure drop across venturi or vane deflection
 - Composition: density, conductivity, GC, IR, NIR, UV

MEASUREMENT DEVICE

- **Transducer: Sensor+Transmitter**
 - Transmitter generates an industrial standard signal from the sensor output.
 - Standard instrumentation signal levels
 - Voltage: 1~5VDC, 0~5VDC, -10~+10VDC, etc.
 - Current: 4~20mA (long range transmission with driver)
 - Pneumatic: 3-15psig
 - Signal conversion
 - I/P or P/I transducer: current-to-pressure or vice versa
 - I/V (I/E) or V/I: current-to-voltage or vice versa
 - P/E or E/P: pressure-to-voltage or vice versa
- **Analog-to-Digital (A/D) converter**
 - Continuous signal converted to digital signal after sampling
 - Specification: sample rate, resolution (8bit, 12bit, 16bit)

TRANSMITTERS

- **Transmitter Gain (K_m): adjustable**
 - Amplification ratio: (output span)/(input span)
- **Span and Zero: adjustable**
 - Span: magnitude of range of transmitter signal
 - Zero: lower limit of transmitter signal

Ex) Temp. Transmitter

$$K_m = \frac{(20mA - 4mA)}{(150^\circ C - 50^\circ C)} = 0.16 [mA/^\circ C]$$

span=100°C

zero=50°C

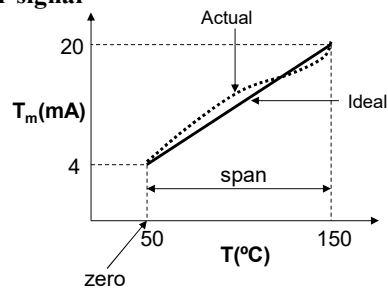

- **Other functions: square-root extractor, ...**

TEMPERATURE SENSORS

Principle	Type	Usable range (°C)	Remarks
Thermal Expansion	Gas expansion	-230~600	N2
	Liquid	-200~350	Oil
	Bimetal	-50~500	
Resistance	Pt-100	-200~500	Accurate, linear, self heating
	Thermistor	<300	Cheap, inaccurate, nonlinear
EMF	Thermocouple	-200~1600	Low sensitivity
	IC temp. sensor	-100~150	High voltage, accurate, linear
Radiation	Pyrometer	Very wide	Noncontacting, need accurate calibration

Temperature Sensor Attributes			
Criteria	Thermocouple	RTD	Thermistor
Cost-OEM Quality	Low	High	Low
Temperature Range	Very wide -450°F +4200°F	Wide -400°F +1200°F	Shot to medium -100°F +500°F
Interchangeability	Good	Excellent	Poor to fair
Long-term Stability	Poor to fair	Good	Poor
Accuracy	Medium	High	Medium
Repeatability	Poor to fair	Excellent	Fair to good
Sensitivity (output)	Low	Medium	Very high
Response	Medium to fast	Medium	Medium to fast
Linearity	Fair	Good	Poor
Self Heating	No	Very low to low	High
Point (end) Sensitive	Excellent	Fair	Good
Lead Effect	High	Medium	Low
Size/Packaging	Small to large	Medium to small	Small to medium

Temperature Sensor Advantages/Disadvantages		
Sensor	Advantages	Disadvantages
Thermocouple	<ul style="list-style-type: none"> •Self-powered •Simple •Rugged •Inexpensive •Wide variety •Wide range 	<ul style="list-style-type: none"> •Non-linear •Low voltage •Reference required •Least stable •Least sensitive
RTD	<ul style="list-style-type: none"> •Most stable and accurate •Area sensing •More linear than thermocouple •Most repeatable •Contamination resistant 	<ul style="list-style-type: none"> •Expensive •Current source required •Slow response time •Low sensitivity to small T change •Self heating
Thermistor	<ul style="list-style-type: none"> •High output •Fast •Economic •Two-wire ohms measurement 	<ul style="list-style-type: none"> •Non-linear •Limited range •Fragile •Current source required •Self heating
Infrared	<ul style="list-style-type: none"> •No contact required •Very fast response time •Good stability over time •High repeatability •No oxidation/corrosion to affect sensor 	<ul style="list-style-type: none"> •High initial cost •More complex/support electronics •Spot size restricts application •Emissivity variations affect readings •Accuracy affected by dust, smoke and background radiation

THERMOCOUPLE

- **Thermocouple Types**
 - Chromel- alumel (K- type): most popularly used
 - Iron- constantan (J- type): higher electromotive force (emf)
 - Chromel- constantan (E- Type): cryogenic temperature
 - 13% Rh. Pt – Pt (R- type): high temperature (> 900°C)
- **Typical emf is about 0.041mV/°C for K type**
 - Needs signal amplification
- **Ice point can be a ice bath or an electronic device to compensate the ambient temperature.**

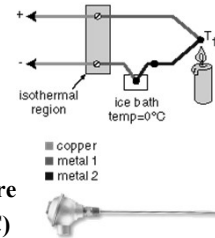

Thermocouple type	Overall Range (°C)	EMF (mV/ °C)
B (Platinum / Rhodium)	100~1800	0.01
E (Chromel / Constantan)	-270~790	0.068
J (Iron / Constantan)	-210~1050	0.054
K (Chromel / Alumel)	-270~1370	0.041
N (Nicrosil / Nisil)	-260~1300	0.038
R (Platinum / Rhodium)	-50~1760	0.01
S (Platinum / Rhodium)	-50~1760	0.01
T (Copper / Constantan)	-270~400	0.054

- B,R,S: high temp. low sensitivity, high cost
- S: very stable, use as the standard of calibration for the melting point of gold (1064.43°C).
- N: improved type K, getting more popular
- T: cryogenic use
- Ref: <http://www.watlow.com/reference/refdata/TOP>
<http://www.picotech.com/applications/thermocouple.html>

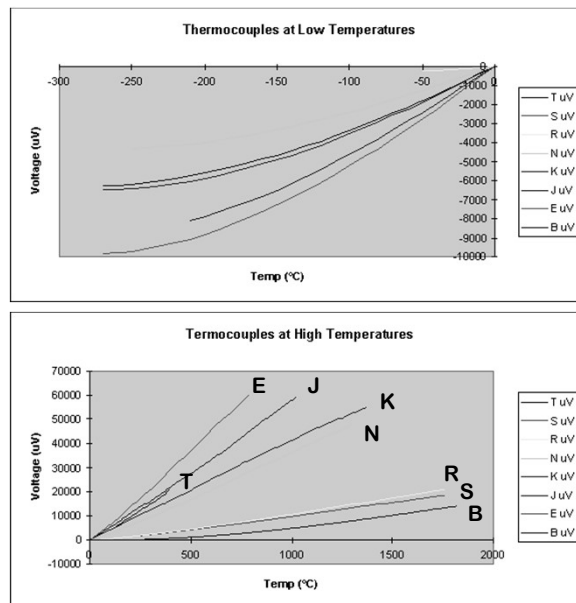

RESISTANCE TEMPERATURE DETECTOR (RTD)

- Resistance changes as temperature changes.
- Platinum (Pt100Ω) is widely used. Copper (Cu) and tungsten (W) are used sometimes. (ASME 0.385Ω/°C, JIS 0.392Ω/°C)
- Distance between sensor and converter should be considered.
 - Connecting wire has resistance and should be compensated.

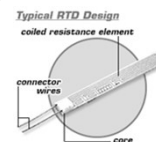

- **Advantages**
 - Rugged
 - High accuracy (about ~0.2°C)
 - Good repeatability
- **Disadvantages**
 - Requires a converter from resistance to electrical signal
 - Higher price than thermocouple
 - Large tip limits the usage in narrow spots

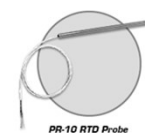

FLOW MEASUREMENT (1)

- **Differential Pressure Cell**

$$Q = \frac{C_d A_2}{\sqrt{1 - (A_2/A_1)^2}} \sqrt{\frac{2g_c \Delta P}{\rho}}$$

- ΔP : Delta P across the orifice
 - A_1 : area of flow pipe
 - A_2 : area of orifice
 - C_d : orifice coefficient
- Maximum pressure drop should be < 4% of the total line pressure
 - Selection of orifice size and delta P range is very important for the reading precision

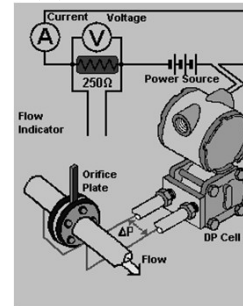

CHBE320 Process Dynamics and Control

Korea University 2-13

FLOW MEASUREMENT(2)

- **Vortex Flow Meter**

- The vortices create low and high pressure zones behind the bluff body.
- The vortex meter uses a piezoelectric crystal sensor to detect the pressure exerted by the vortices on the sensing wing.
- The piezoelectric crystal converts this vortex shedding frequency into electrical signals.

- **Electromagnetic Flow Meter**

- Electrically conducting fluid passing through a magnetic field created by the device.

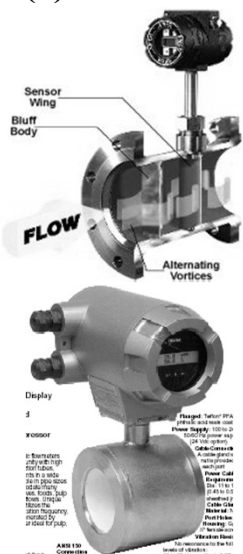

CHBE320 Process Dynamics and Control

Korea University 2-14

CORIOLIS FLOWMETER (3)

- Flow rate is measured by Coriolis effect (1835)
- Mass flowrate, vol. flowrate, temp. and density are simultaneously measured.

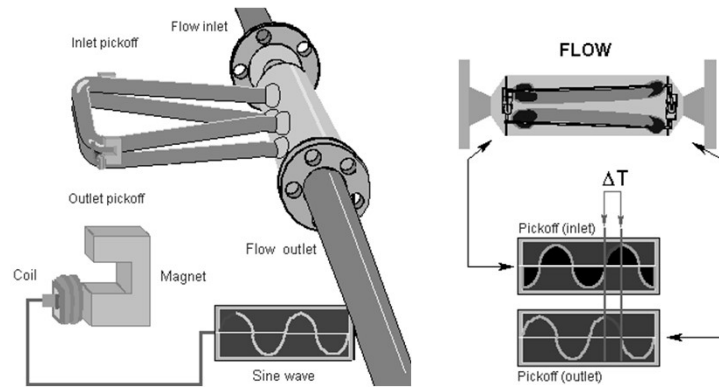
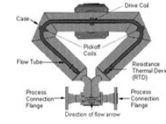

<http://www.emersonprocess.com/micromotion/tutor/default.html>

CHBE320 Process Dynamics and Control

Korea University 2-15

FLOW MEASUREMENT (4)

- **Ultrasonic Flow Meter**

- High accuracy
- No contact with flow

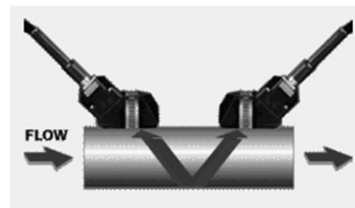

- **Positive Displacement Flow Meter**

- Turbine, gear, wheels

- **Thermal Dispersion Flow Meter**

- Flow over heating coil will change temperature

CHBE320 Process Dynamics and Control

Korea University 2-16

SELECTION OF FLOWMETERS

Requirement	Orifice	Positive displacement	Vortex	Electro-Magnetic	Acoustic	Coriolis
accuracy	±2~4% of full span	±0.2~0.5 % of rate	±1.0% of rate	±0.5% of rate	±1~5% of full span	±0.5% of rate
Press. loss	medium	high	medium	none	none	low
Initial Cost	low	medium	high	high	high	very high
Maintenance cost	high	medium	medium	low	low	low
Application	Clean, dirty liq.; some slurry	Clean viscous liq.	Clean, dirty liq.;	Clean, dirty viscous conductive liq. and slurry	Dirty, viscous liq. and slurry	Clean, dirty viscous liq. and some slurry
Upstream pipe size	10~30	None	10 to 20	5	5 to 30	none
Viscosity effect	high	high	medium	none	none	none
Rangeability	4 to 1	10 to 1	10 to 1	40 to 1	20 to 1	10 to 1

CHBE320 Process Dynamics and Control

Korea University 2-17

LEVEL MEASUREMENT

- Float level sensor
- Ultrasonic level sensor
- Use of DP cell
 - Measure fluid head as Delta P
 - Various implementation

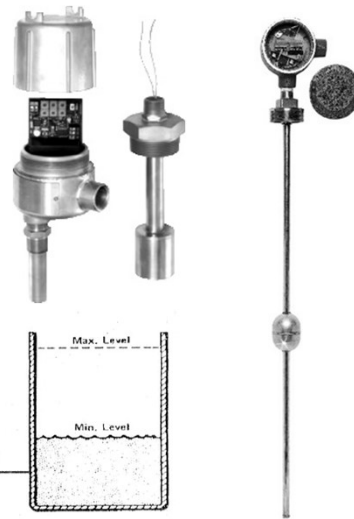
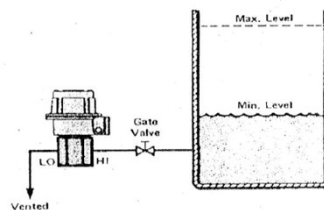
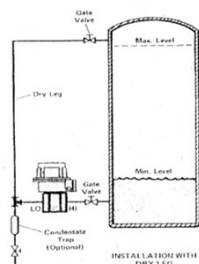

CHBE320 Process Dynamics and Control

Korea University 2-18

WEIGHT MEASUREMENT

- **Strain Gauge Load Cell**

- Replacement of mechanical balance when electrical signals is required (force is converted to electrical signal)
- Usually 4 strain gauges are mounted on a structure such as beam
- Two for measuring tension and two for compression (change in resistance)
- Wheatstone bridge

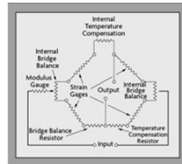

- **Types**

- Bending beam
- Ring (Pancake)
- Shear beam, etc.

- **Advantages/Disadvantages**

- High accuracy (0.03%~0.1%)
- Produced in various forms and shapes
- Accuracy degradation when the load is moving



OTHER MEASUREMENTS

- **Composition measurements**

- Expensive
- Long time delay
- High maintenance cost

- **Gas Chromatography**

- IR, NIR, Raman, UV spectrophotometer
- pH sensor electrode: concentration of [H⁺]
- Dissolved oxygen, conductivity, etc.



- **Secondary Measurements**

- Density or temp. for binary composition

- **Soft Sensors**

- Estimated by a model based on other measurements



MEASUREMENT USING NIR

- **Near InfraRed (NIR) Light**

- Depending on the wave length of light

- Near IR: 0.7-2.5 μm
- Mid IR: 2.5-10 μm
- Far IR: 10-1000 μm

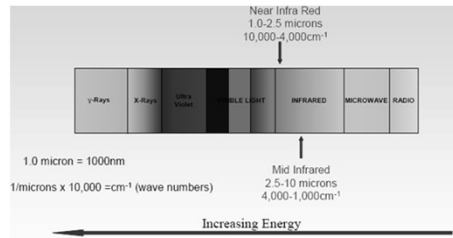

- Different molecular bonds absorb different wave length of light and it is converted to the vibration of the molecules.

- O-H bond in water
- C-H bond in organic substance or fat
- N-H bond in protein

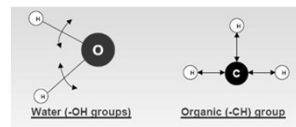

CHBE320 Process Dynamics and Control

Korea University 2-21

- **NIR Sensor**

- Using filter wheel in front of light source, different wave length of the light is emitted as pulse.

- The concentration is obtained by analyzing the spectrum of reflected light.

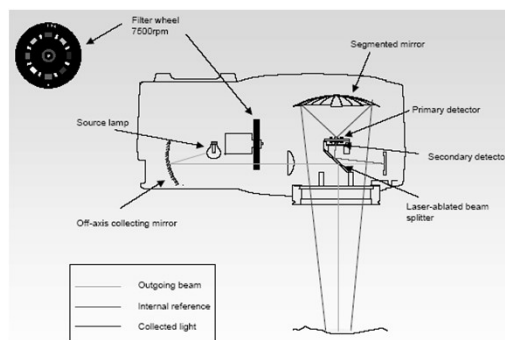
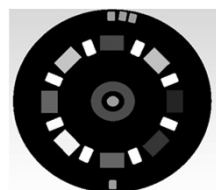

CHBE320 Process Dynamics and Control

Korea University 2-22

- **Measurement of properties using NIR**

- **Composition or contents**

- Moisture
 - Fat
 - Protein
 - Sugar
 - Nicotine
 - Caffeine
 - Etc.



- **Physical dimensions**

- Coating weight)
 - Film thickness
 - Etc.

FILTERING

- **Noise Source**

- Process nature (turbulence, vibration, oscillation...)
 - Various noise source from environment
 - Power line, electromagnetic force, etc.

- **Removing noise**

- **Analog filter**

$$\tau_F \frac{dy_F}{dt} + y_F = y \quad \leftarrow \text{Measured output}$$

τ_F ← Filter time constant y_F ← Filtered output

- **First-order filter analogy**

$$\tau_F \frac{y_F - y_F^0}{\Delta t} + y_F = y \quad \leftarrow \text{Previous filtered output}$$

$$y_F = \alpha y_F^0 + (1 - \alpha)y \quad \text{where } \alpha = \frac{\tau_F / \Delta t}{1 + \tau_F / \Delta t} \quad (0 < \alpha < 1)$$

- The filter behaves as an interpolation between the measured output and previous filtered output.
- If $\alpha=1$, the measured output is ignored. (constant)
- If $\alpha=0$, the filtered output is same as the measured output (no filtering)
- If $\tau_F=0$, $\alpha=0$ and no filtering is achieved.
- If $\tau_F=\infty$, $\alpha=1$ and the measured output is ignored.
 \Rightarrow As τ_F increases, heavier filter is applied.

