

 *Bioprocess lab.*

Experiments of HPLC

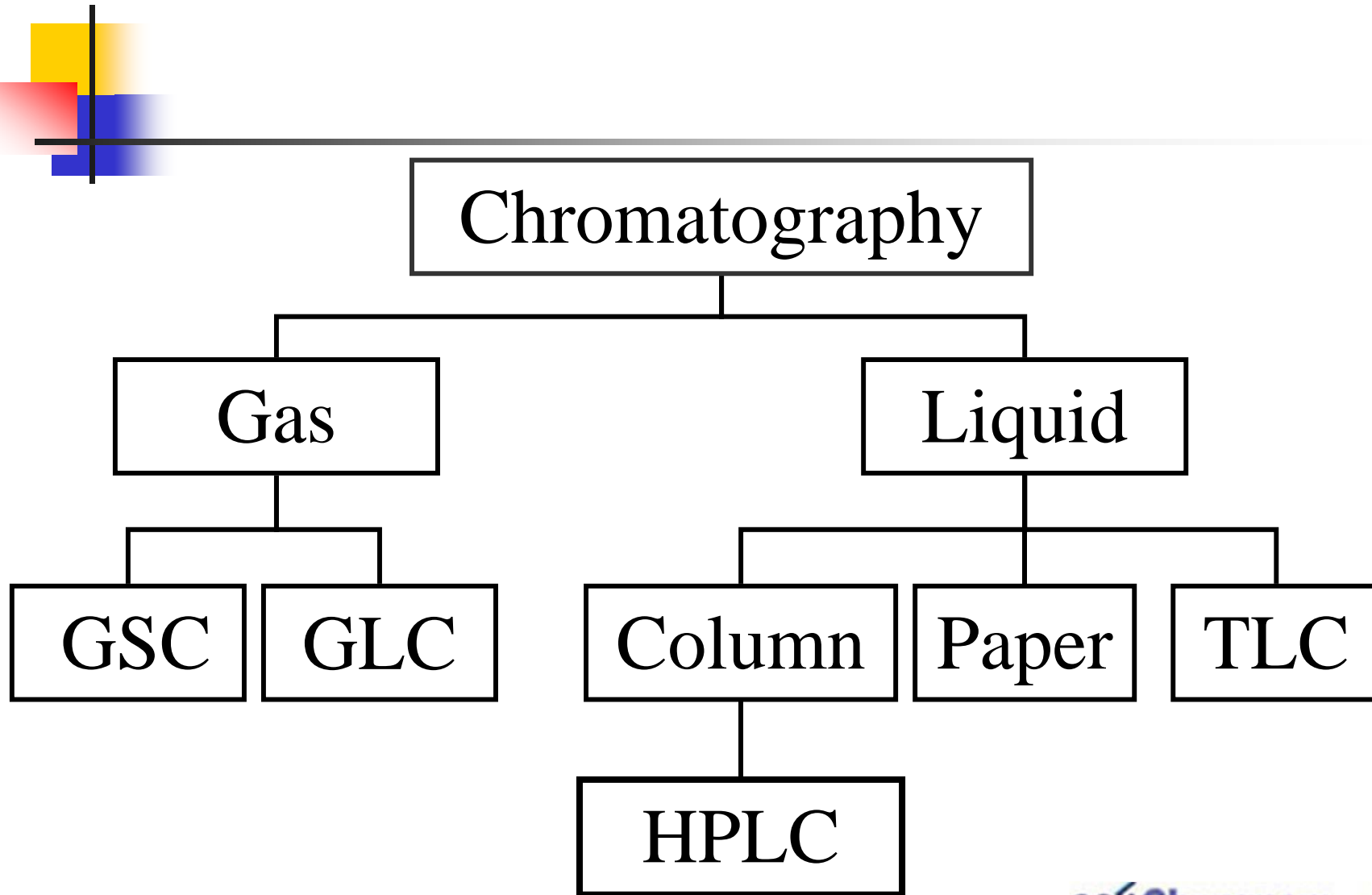

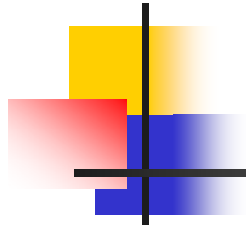



■ HPLC

- High performance liquid chromatography.
- Rapid separation method.
- Variety of mobile phase and stationary phase.

✦ *Bioprocess lab.*

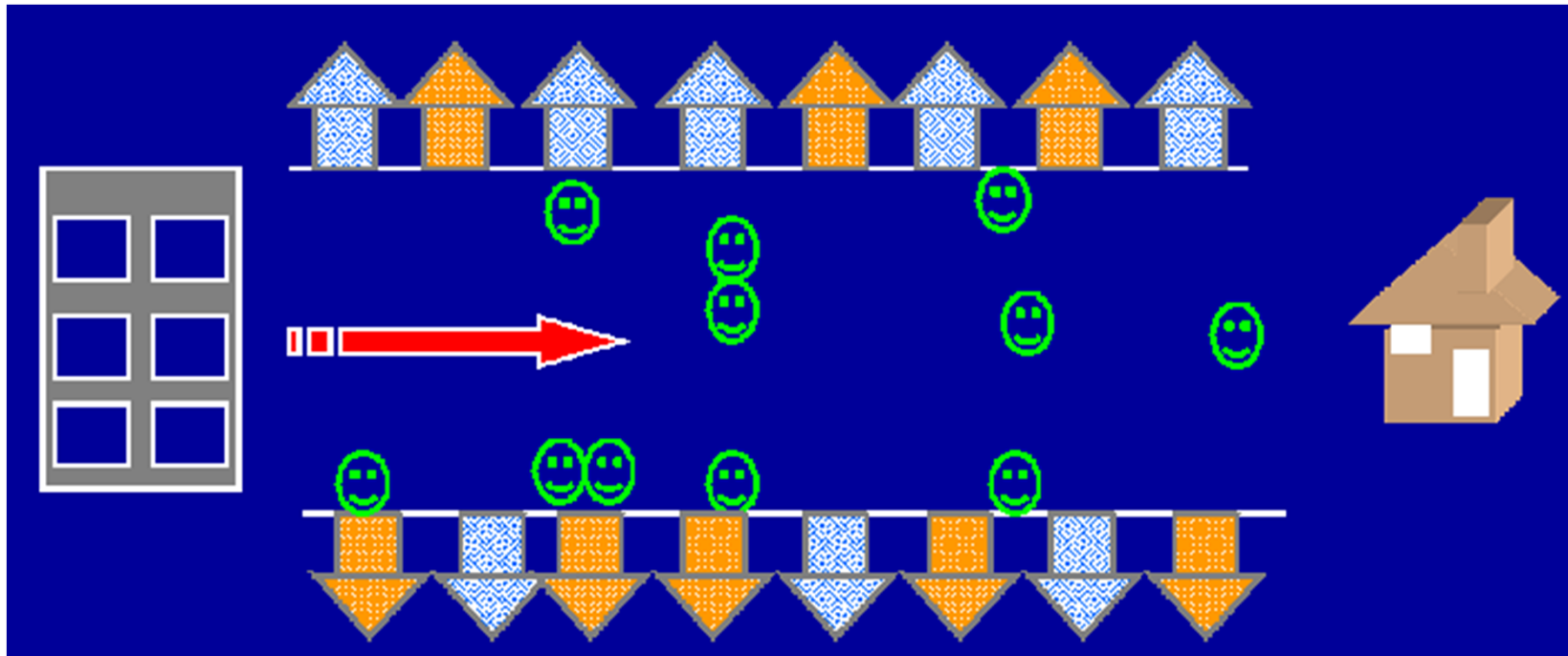
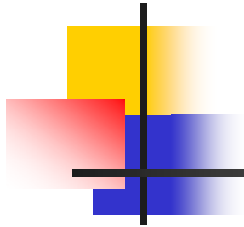

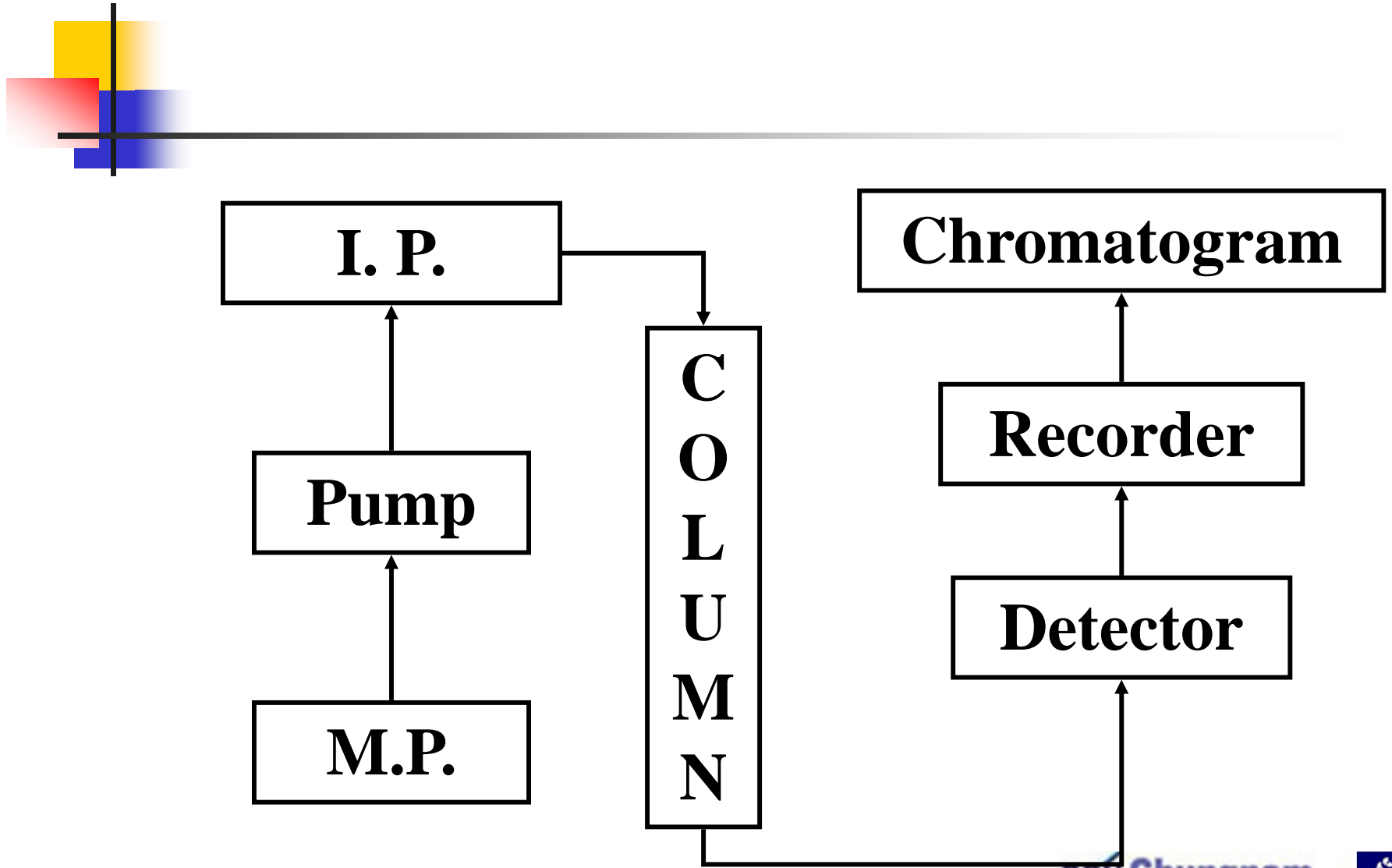

Analytical result from HPLC

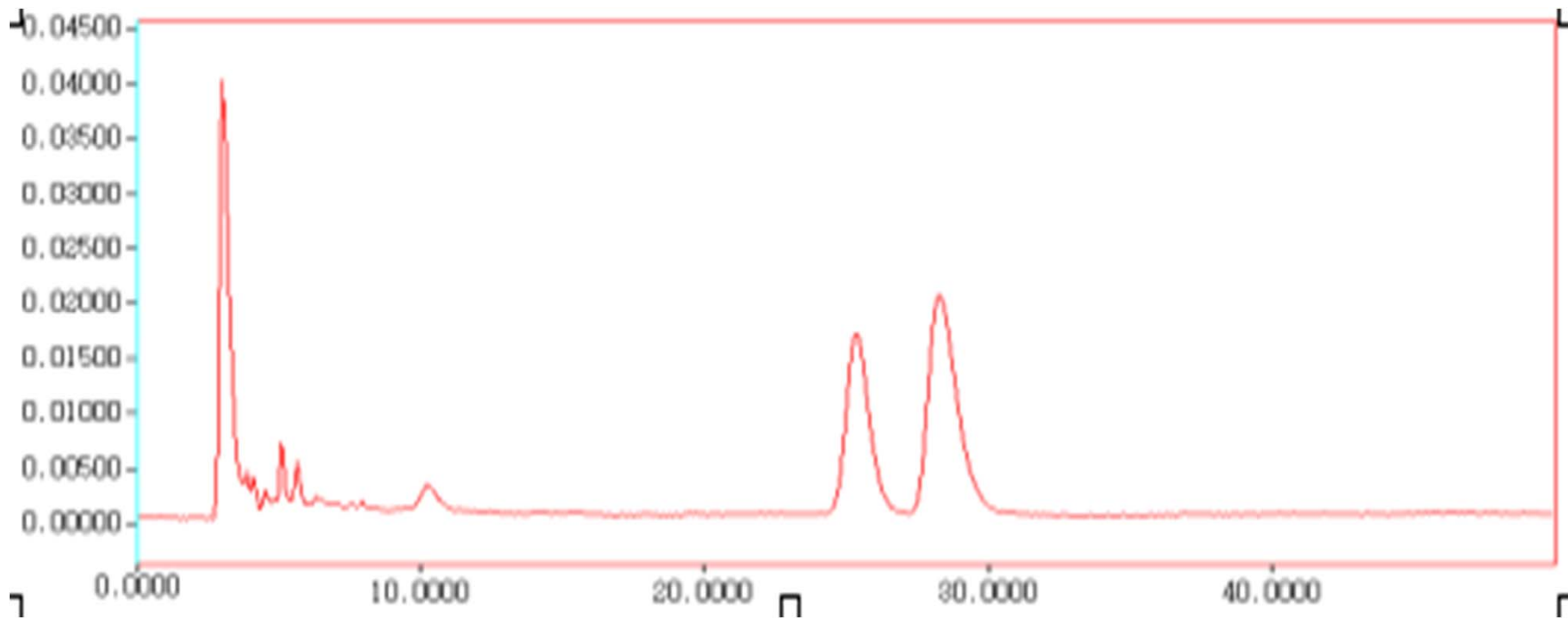

Experiments

1.



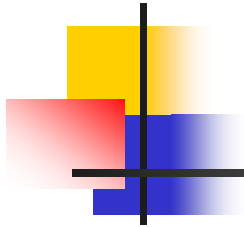

2. Filtration and degassing



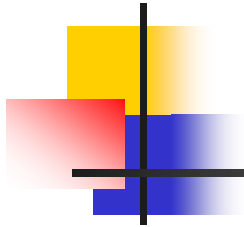

3.



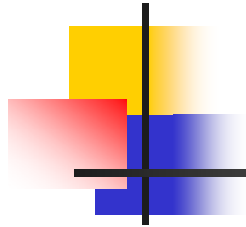

4. Column



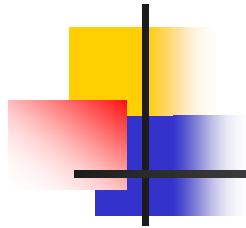

5. Pump



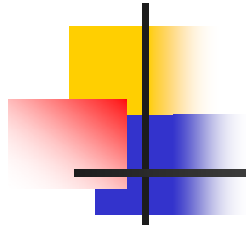

6. Column

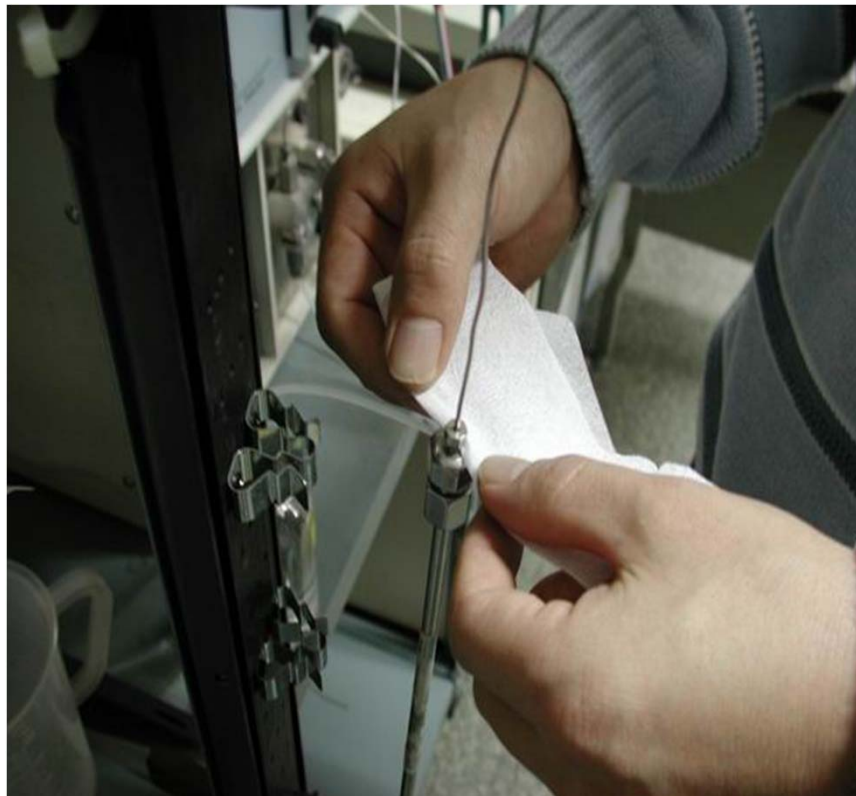

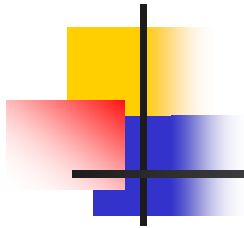

7.



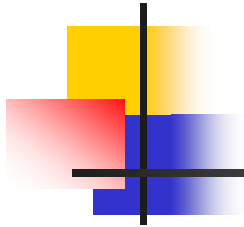

8. UV Detector



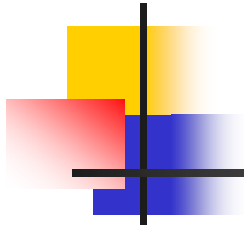

9. Sample preparation



10. Sample filtration



11. Injection

