

CHE302 LECTURE V
LAPLACE TRANSFORM AND
TRANSFER FUNCTION

Professor Dae Ryook Yang

Fall 2001

Dept. of Chemical and Biological Engineering
Korea University

SOLUTION OF LINEAR ODE

- **1st-order linear ODE**

- **Integrating factor:** For $\frac{dx}{dt} + a(t)x = f(x)$, I.F. = $\exp(\int a(t)dt)$

$$[xe^{\int a(t)dt}]' = f(t)e^{\int a(t)dt} \longrightarrow x(t) = [\int f(t)e^{\int a(t)dt} dt + C]e^{-\int a(t)dt}$$

- **High-order linear ODE with constant coeffs.**

- **Modes: roots of characteristic equation**

For $a_2x'' + a_1x' + a_0x = f(t)$,

$$a_2p^2 + a_1p + a_0 = a_2(p - p_1)(p - p_1) = 0$$

- **Depending on the roots, modes are**

- **Distinct roots:** (e^{-p_1t}, e^{-p_2t})
 - **Double roots:** (e^{-p_1t}, te^{-p_1t})
 - **Imaginary roots:** $(e^{-at} \cos bt, e^{-at} \sin bt)$

Solution is a linear combination of modes and the coefficients are decided by the initial conditions.

- **Many other techniques for different cases**

LAPLACE TRANSFORM FOR LINEAR ODE AND PDE

- **Laplace Transform**

- Not in time domain, rather in frequency domain
- Derivatives and integral become some operators.
- ODE is converted into algebraic equation
- PDE is converted into ODE in spatial coordinate
- Need inverse transform to recover time-domain solution

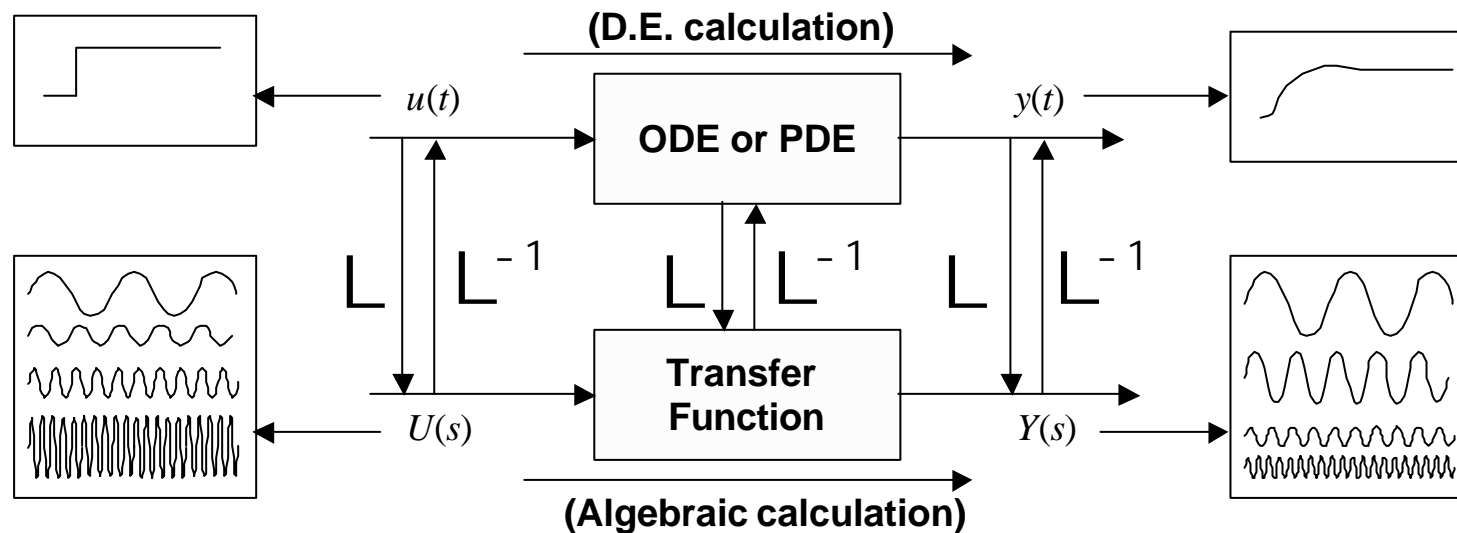

DEFINITION OF LAPLACE TRANSFORM

- **Definition**

$$F(s) = \mathcal{L}\{f(t)\} \triangleq \int_0^{\infty} f(t)e^{-st} dt$$

- $F(s)$ is called *Laplace transform* of $f(t)$.
- $f(t)$ must be piecewise continuous.
- $F(s)$ contains no information on $f(t)$ for $t < 0$.
- The past information on $f(t)$ (for $t < 0$) is irrelevant.
- The s is a complex variable called “*Laplace transform variable*”

- **Inverse Laplace transform**

$$f(t) = \mathcal{L}^{-1}\{F(s)\}$$

- \mathcal{L} and \mathcal{L}^{-1} are linear. $\mathcal{L}\{af_1(t) + bf_2(t)\} = aF_1(s) + bF_2(s)$

LAPLACE TRANSFORM OF FUNCTIONS

- **Constant function, a**

$$\mathcal{L}\{a\} = \int_0^{\infty} a e^{-st} dt = -\frac{a}{s} e^{-st} \Big|_0^{\infty} = 0 - \left(-\frac{a}{s}\right) = \frac{a}{s}$$

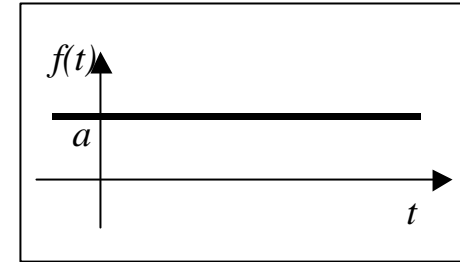

- **Step function, $S(t)$**

$$f(t) = S(t) = \begin{cases} 1 & \text{for } t \geq 0 \\ 0 & \text{for } t < 0 \end{cases}$$

$$\mathcal{L}\{S(t)\} = \int_0^{\infty} e^{-st} dt = -\frac{1}{s} e^{-st} \Big|_0^{\infty} = 0 - \left(-\frac{1}{s}\right) = \frac{1}{s}$$

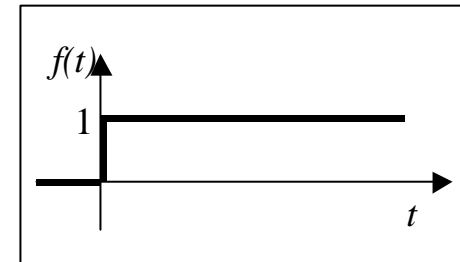

- **Exponential function, e^{-bt}**

$$\mathcal{L}\{e^{-bt}\} = \int_0^{\infty} e^{-bt} e^{-st} dt = \frac{-1}{s+b} e^{-(b+s)t} \Big|_0^{\infty} = \frac{1}{s+b}$$

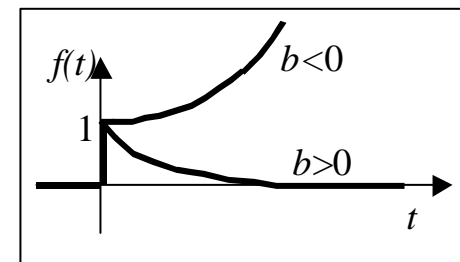

- **Trigonometric functions**

- **Euler's Identity:** $e^{j\omega t} \triangleq \cos \omega t + j \sin \omega t$

$$\cos \omega t = \frac{1}{2}(e^{j\omega t} + e^{-j\omega t}) \quad \sin \omega t = \frac{1}{2j}(e^{j\omega t} - e^{-j\omega t})$$

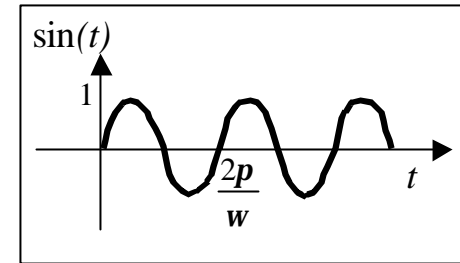

$$\mathcal{L}\{\sin \omega t\} = \mathcal{L}\left\{\frac{1}{2j}e^{j\omega t}\right\} - \mathcal{L}\left\{\frac{1}{2j}e^{-j\omega t}\right\} = \frac{1}{2j}\left(\frac{1}{s - j\omega} - \frac{1}{s + j\omega}\right) = \frac{\omega}{s^2 + \omega^2}$$

$$\mathcal{L}\{\cos \omega t\} = \mathcal{L}\left\{\frac{1}{2}e^{j\omega t}\right\} + \mathcal{L}\left\{\frac{1}{2}e^{-j\omega t}\right\} = \frac{1}{2}\left(\frac{1}{s - j\omega} + \frac{1}{s + j\omega}\right) = \frac{s}{s^2 + \omega^2}$$

- **Rectangular pulse, P(t)**

$$f(t) = P(t) = \begin{cases} 0 & \text{for } t > t_w \\ h & \text{for } t_w \geq t \geq 0 \\ 0 & \text{for } t < 0 \end{cases}$$

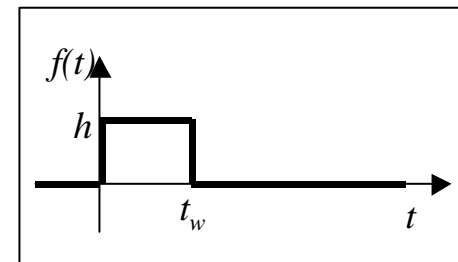

$$\mathcal{L}\{P(t)\} = \int_0^{t_w} h e^{-st} dt = -\frac{h}{s} e^{-st} \Big|_0^{t_w} = \frac{h}{s} (1 - e^{-t_w s})$$

- **Impulse function, $d(t)$**

$$f(t) = d(t) = \lim_{t_w \rightarrow 0} \begin{cases} 0 & \text{for } t > t_w \\ 1/t_w & \text{for } t_w \geq t \geq 0 \\ 0 & \text{for } t < 0 \end{cases}$$

$$\mathcal{L}\{d(t)\} = \lim_{t_w \rightarrow 0} \int_0^{t_w} \frac{1}{t_w} e^{-st} dt = \lim_{t_w \rightarrow 0} \frac{1}{t_w s} (1 - e^{-t_w s}) = 1$$

$$\left(\text{L'Hospital's rule: } \lim_{t \rightarrow 0} \frac{f(t)}{g(t)} = \lim_{t \rightarrow 0} \frac{f'(t)}{g'(t)} \right)$$

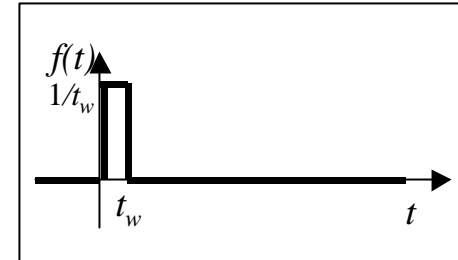

- **Ramp function, t**

$$\mathcal{L}\{t\} = \int_0^{\infty} t e^{-st} dt$$

$$= \frac{t}{-s} e^{-st} \Big|_0^{\infty} - \int_0^{\infty} \frac{e^{-st}}{-s} dt = \frac{1}{s} \int_0^{\infty} e^{-st} dt = \frac{1}{s^2}$$

$$\left(\text{Integration by part: } \int_0^{\infty} f' \cdot g dt = f \cdot g \Big|_0^{\infty} - \int_0^{\infty} f \cdot g' dt \right)$$

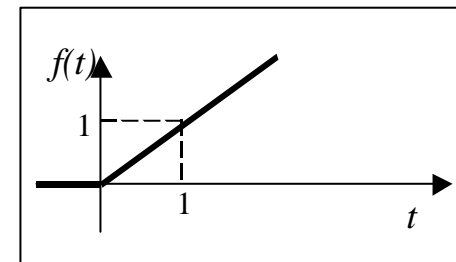

- **Refer the Table 3.1 (Seborg et al.) for other functions**

Table 3.1 Laplace Transforms for Various Time-Domain Functions*

	$f(t)$	$F(s)$
1.	$\delta(t)$ (unit impulse)	1
2.	$S(t)$ (unit step)	$\frac{1}{s}$
3.	t (ramp)	$\frac{1}{s^2}$
4.	t^{n-1}	$\frac{(n-1)!}{s^n}$
5.	e^{-bt}	$\frac{1}{s+b}$
6.	$\frac{1}{\tau} e^{-t/\tau}$	$\frac{1}{\tau s + 1}$
7.	$\frac{t^{n-1} e^{-bt}}{(n-1)!}$ ($n > 0$)	$\frac{1}{(s+b)^n}$
8.	$\frac{1}{\tau^n (n-1)!} t^{n-1} e^{-t/\tau}$	$\frac{1}{(\tau s + 1)^n}$
9.	$\frac{1}{b_1 - b_2} (e^{-b_2 t} - e^{-b_1 t})$	$\frac{1}{(s+b_1)(s+b_2)}$
10.	$\frac{1}{\tau_1 - \tau_2} (e^{-t/\tau_1} - e^{-t/\tau_2})$	$\frac{1}{(\tau_1 s + 1)(\tau_2 s + 1)}$
11.	$\frac{b_3 - b_1}{b_2 - b_1} e^{-b_1 t} + \frac{b_3 - b_2}{b_1 - b_2} e^{-b_2 t}$	$\frac{s + b_3}{(s + b_1)(s + b_2)}$
12.	$\frac{1}{\tau_1 \tau_1 - \tau_2} e^{-t/\tau_1} + \frac{1}{\tau_2 \tau_2 - \tau_1} e^{-t/\tau_2}$	$\frac{\tau_3 s + 1}{(\tau_1 s + 1)(\tau_2 s + 1)}$
13.	$1 - e^{-t/\tau}$	$\frac{1}{s(\tau s + 1)}$
14.	$\sin \omega t$	$\frac{\omega}{s^2 + \omega^2}$

Table 3.1 (Continued)

	$f(t)$	$F(s)$
15.	$\cos \omega t$	$\frac{s}{s^2 + \omega^2}$
16.	$\sin (\omega t + \phi)$	$\frac{\omega \cos \phi + s \sin \phi}{s^2 + \omega^2}$
17.	$e^{-bt} \sin \omega t$	$\left. \begin{array}{l} \frac{\omega}{(s+b)^2 + \omega^2} \\ \frac{s+b}{(s+b)^2 + \omega^2} \\ \frac{1}{\tau^2 s^2 + 2\zeta\tau s + 1} \end{array} \right\} \begin{array}{l} b, \omega \text{ real} \\ \\ \end{array}$
18.	$e^{-bt} \cos \omega t$	
19.	$\frac{1}{\tau\sqrt{1-\zeta^2}} e^{-\zeta t/\tau} \sin(\sqrt{1-\zeta^2} t/\tau)$ ($0 \leq \zeta < 1$)	$\frac{1}{\tau^2 s^2 + 2\zeta\tau s + 1}$
20.	$1 + \frac{1}{\tau_2 - \tau_1} (\tau_1 e^{-t/\tau_1} - \tau_2 e^{-t/\tau_2})$ ($\tau_1 \neq \tau_2$)	$\frac{1}{s(\tau_1 s + 1)(\tau_2 s + 1)}$
21.	$1 - \frac{1}{\sqrt{1-\zeta^2}} e^{-\zeta t/\tau} \sin[\sqrt{1-\zeta^2} t/\tau + \psi]$ $\psi = \tan^{-1} \frac{\sqrt{1-\zeta^2}}{\zeta}$ ($0 \leq \zeta < 1$)	$\frac{1}{s(\tau^2 s^2 + 2\zeta\tau s + 1)}$
22.	$1 - e^{-\zeta t/\tau} [\cos(\sqrt{1-\zeta^2} t/\tau) + \frac{\zeta}{1-\zeta^2} \sin(\sqrt{1-\zeta^2} t/\tau)]$ ($0 \leq \zeta < 1$)	$\frac{1}{s(\tau^2 s^2 + 2\zeta\tau s + 1)}$
23.	$1 + \frac{\tau_3 - \tau_1}{\tau_1 - \tau_2} e^{-t/\tau_1} + \frac{\tau_3 - \tau_2}{\tau_2 - \tau_1} e^{-t/\tau_2}$ ($\tau_1 \neq \tau_2$)	$\frac{\tau_3 s + 1}{s(\tau_1 s + 1)(\tau_2 s + 1)}$
24.	$\frac{df}{dt}$	$sF(s) - f(0)$
25.	$\frac{d^n f}{dt^n}$	$s^n F(s) - s^{n-1} f(0) - s^{n-2} f'(0) - \dots - s f^{(n-2)}(0) - f^{(n-1)}(0)$

^aNote that $f(t)$ and $F(s)$ are defined for $t \geq 0$ only.

PROPERTIES OF LAPLACE TRANSFORM

- **Differentiation**

$$\begin{aligned} \mathcal{L}\left\{\frac{df}{dt}\right\} &= \int_0^{\infty} f' \cdot e^{-st} dt = f(t)e^{-st} \Big|_0^{\infty} - \int_0^{\infty} f \cdot (-s)e^{-st} dt \quad (\text{by i.b.p.}) \\ &= s \int_0^{\infty} f \cdot e^{-st} dt - f(0) = sF(s) - f(0) \end{aligned}$$

$$\begin{aligned} \mathcal{L}\left\{\frac{d^2 f}{dt^2}\right\} &= \int_0^{\infty} f'' \cdot e^{-st} dt = f'(t)e^{-st} \Big|_0^{\infty} - \int_0^{\infty} f' \cdot (-s)e^{-st} dt = s \int_0^{\infty} f' \cdot e^{-st} dt - f'(0) \\ &= s(sF(s) - f(0)) - f'(0) = s^2 F(s) - sf(0) - f'(0) \\ &\vdots \end{aligned}$$

$$\begin{aligned} \mathcal{L}\left\{\frac{d^n f}{dt^n}\right\} &= \int_0^{\infty} f^{(n)} \cdot e^{-st} dt = f^{(n-1)}(t)e^{-st} \Big|_0^{\infty} - \int_0^{\infty} f^{(n-1)} \cdot (-s)e^{-st} dt \\ &= s \int_0^{\infty} f^{(n-1)} \cdot e^{-st} dt - f^{(n-1)}(0) = s \left(\mathcal{L}\left\{\frac{d^{n-1} f}{dt^{n-1}}\right\} \right) - f^{(n-1)}(0) \\ &= s^n F(s) - s^{n-1} f(0) - \dots - sf^{(n-2)}(0) - f^{(n-1)}(0) \end{aligned}$$

- **If $f(0) = f'(0) = f''(0) = \dots = f^{(n-1)}(0) = 0$,**
 - **Initial condition effects are vanished.**
 - **It is very convenient to use deviation variables so that all the effects of initial condition vanish.**

$$\begin{aligned} \mathcal{L}\left\{\frac{df}{dt}\right\} &= sF(s) \\ \mathcal{L}\left\{\frac{d^2f}{dt^2}\right\} &= s^2F(s) \\ &\vdots \\ \mathcal{L}\left\{\frac{d^nf}{dt^n}\right\} &= s^nF(s) \end{aligned}$$

- **Transforms of linear differential equations.**

$$y(t) \xrightarrow{\mathcal{L}} Y(s), \quad u(t) \xrightarrow{\mathcal{L}} U(s)$$

$$\frac{dy(t)}{dt} \xrightarrow{\mathcal{L}} sY(s) \quad (\text{if } y(0) = 0)$$

$$t \frac{dy(t)}{dt} = -y(t) + Ku(t) \quad (y(0) = 0) \xrightarrow{\mathcal{L}} (ts + 1)Y(s) = KU(s)$$

$$\frac{\partial T_L}{\partial t} = -v \frac{\partial T_L}{\partial z} + \frac{1}{t_{HL}} (T_w - T_L) \xrightarrow{\mathcal{L}} t_{HL} v \frac{\partial \tilde{T}_L(s)}{\partial z} + (t_{HL} s + 1) \tilde{T}_L(s) = \tilde{T}_w(s)$$

- **Integration**

$$\begin{aligned} \mathcal{L}\left\{\int_0^t f(\mathbf{x})d\mathbf{x}\right\} &= \int_0^\infty \left(\int_0^t f(\mathbf{x})d\mathbf{x}\right)e^{-st} dt \\ &= \frac{e^{-st}}{-s} \int_0^t f(\mathbf{x})d\mathbf{x} \Big|_0^\infty + \frac{1}{s} \int_0^\infty f \cdot e^{-st} dt = \frac{F(s)}{s} \quad (\text{by } i.b.p.) \end{aligned}$$

$$\left(\text{Leibniz rule: } \frac{d}{dt} \int_{a(t)}^{b(t)} f(t)dt = f(b(t)) \frac{db(t)}{dt} - f(a(t)) \frac{da(t)}{dt} \right)$$

- **Time delay (Translation in time)**

$$f(t) \xrightarrow{+q \text{ in } t} f(t-q)S(t-q)$$

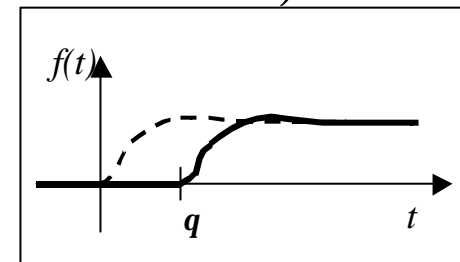

$$\begin{aligned} \mathcal{L}\{f(t-q)S(t-q)\} &= \int_q^\infty f(t-q)e^{-st} dt = \int_0^\infty f(t)e^{-s(t+q)} dt \quad (\text{let } t = t-q) \\ &= e^{-qs} \int_0^\infty f(t)e^{-ts} dt = e^{-qs} F(s) \end{aligned}$$

- **Derivative of Laplace transform**

$$\frac{dF(s)}{ds} = \frac{d}{ds} \int_0^\infty f \cdot e^{-st} dt = \int_0^\infty f \cdot \frac{d}{ds} e^{-st} dt = \int_0^\infty (-t \cdot f) e^{-st} dt = \mathcal{L}[-t \cdot f(t)]$$

- **Final value theorem**

- **From the LT of differentiation, as s approaches to zero**

$$\lim_{s \rightarrow 0} \int_0^{\infty} \frac{df}{dt} \cdot e^{-st} dt = \lim_{s \rightarrow 0} [sF(s) - f(0)]$$

$$\int_0^{\infty} \frac{df}{dt} dt = f(\infty) - f(0) = \lim_{s \rightarrow 0} sF(s) - f(0) \Rightarrow f(\infty) = \lim_{s \rightarrow 0} sF(s)$$

- **Limitation: $f(\infty)$ has to exist. If it diverges or oscillates, this theorem is not valid.**

- **Initial value theorem**

- **From the LT of differentiation, as s approaches to infinity**

$$\lim_{s \rightarrow \infty} \int_0^{\infty} \frac{df}{dt} \cdot e^{-st} dt = \lim_{s \rightarrow \infty} [sF(s) - f(0)]$$

$$\lim_{s \rightarrow \infty} \int_0^{\infty} \frac{df}{dt} e^{-st} dt = 0 = \lim_{s \rightarrow \infty} sF(s) - f(0) \Rightarrow f(0) = \lim_{s \rightarrow \infty} sF(s)$$

EXAMPLE ON LAPLACE TRANSFORM (1)

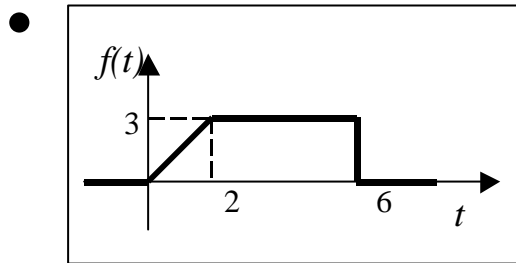

$$f(t) = \begin{cases} 1.5t & \text{for } 0 \leq t < 2 \\ 3 & \text{for } 2 \leq t < 6 \\ 0 & \text{for } 6 \leq t \\ 0 & \text{for } t < 0 \end{cases}$$

$$f(t) = 1.5tS(t) - 1.5(t-2)S(t-2) - 3S(t-6)$$

$$\therefore F(s) = \mathcal{L}\{f(t)\} = \frac{1.5}{s^2}(1 - e^{-2s}) - \frac{3}{s}e^{-6s}$$

- For $F(s) = \frac{2}{s-5}$, find $f(0)$ and $f(\infty)$.

- Using the initial and final value theorems

$$f(0) = \lim_{s \rightarrow \infty} sF(s) = \lim_{s \rightarrow \infty} \frac{2s}{s-5} = 2 \quad f(\infty) = \lim_{s \rightarrow 0} sF(s) = \lim_{s \rightarrow 0} \frac{2s}{s-5} = 0$$

- But the final value theorem is not valid because

$$\lim_{t \rightarrow \infty} f(t) = \lim_{t \rightarrow \infty} 2e^{5t} = \infty$$

EXAMPLE ON LAPLACE TRANSFORM (2)

- **What is the final value of the following system?**

$$x'' + x' + x = \sin t; \quad x(0) = x'(0) = 0$$

$$\Rightarrow s^2 X(s) + sX(s) + X = \frac{1}{s^2 + 1} \Rightarrow x(s) = \frac{1}{(s^2 + 1)(s^2 + s + 1)}$$

$$x(\infty) \stackrel{\text{⊗}}{=} \lim_{s \rightarrow 0} \frac{s}{(s^2 + 1)(s^2 + s + 1)} = 0$$

– **Actually, $x(\infty)$ cannot be defined due to $\sin t$ term.**

- **Find the Laplace transform for $(t \sin wt)$?**

$$\text{From } \frac{dF(s)}{ds} = \mathcal{L}[-t \cdot f(t)]$$

$$\mathcal{L}[t \cdot \sin wt] = -\frac{d}{ds} \left[\frac{w}{s^2 + w^2} \right] = \frac{2ws}{(s^2 + w^2)^2}$$

INVERSE LAPLACE TRANSFORM

- **Used to recover the solution in time domain**

$$\mathcal{L}^{-1}\{F(s)\} = f(t)$$

- **From the table**
- **By partial fraction expansion**
- **By inversion using contour integral**

$$f(t) = \mathcal{L}^{-1}\{F(s)\} = \frac{1}{2\pi j} \oint_C e^{st} F(s) ds$$

- **Partial fraction expansion**

- **After the partial fraction expansion, it requires to know some simple formula of inverse Laplace transform such as**

$$\frac{1}{(ts+1)}, \frac{s}{(s+b)^2 + w^2}, \frac{(n-1)!}{s^n}, \frac{e^{-qs}}{t^2 s^2 + 2zts + 1}, \text{ etc.}$$

PARTIAL FRACTION EXPANSION

$$F(s) = \frac{N(s)}{D(s)} = \frac{N(s)}{(s + p_1) \cdots (s + p_n)} = \frac{a_1}{(s + p_1)} + \cdots + \frac{a_n}{(s + p_n)}$$

- **Case I: All p_i 's are distinct and real**
 - By a root-finding technique, find all roots (time-consuming)
 - Find the coefficients for each fraction
 - Comparison of the coefficients after multiplying the denominator
 - Replace some values for s and solve linear algebraic equation
 - Use of Heaviside expansion
 - Multiply both side by a factor, $(s+p_i)$, and replace s with $-p_i$.

$$a_i = (s + p_i) \left. \frac{N(s)}{D(s)} \right|_{s=-p_i}$$

- **Inverse LT:**

$$f(t) = a_1 e^{-p_1 t} + a_2 e^{-p_2 t} + \cdots + a_n e^{-p_n t}$$

- **Case II: Some roots are repeated**

$$F(s) = \frac{N(s)}{D(s)} = \frac{N(s)}{(s+p)^r} = \frac{b_{r-1}s^{r-1} + \dots + b_0}{(s+p)^r} = \frac{\mathbf{a}_1}{(s+p)} + \dots + \frac{\mathbf{a}_r}{(s+p)^r}$$

- **Each repeated factors have to be separated first.**
- **Same methods as Case I can be applied.**
- **Heaviside expansion for repeated factors**

$$\mathbf{a}_{r-i} = \frac{1}{i!} \frac{d^{(i)}}{ds^{(i)}} \left(\frac{N(s)}{D(s)} (s+p)^r \right) \Big|_{s=-p} \quad (i = 0, \dots, r-1)$$

- **Inverse LT**

$$f(t) = \mathbf{a}_1 e^{-pt} + \mathbf{a}_2 t e^{-pt} + \dots + \frac{\mathbf{a}_r}{(r-1)!} t^{r-1} e^{-pt}$$

- **Case III: Some roots are complex**

$$F(s) = \frac{N(s)}{D(s)} = \frac{c_1s + c_0}{s^2 + d_1s + d_0} = \frac{\mathbf{a}_1(s + b) + \mathbf{b}_1\mathbf{w}}{(s + b)^2 + \mathbf{w}^2}$$

- Each repeated factors have to be separated first.
- Then,

$$\frac{\mathbf{a}_1(s + b) + \mathbf{b}_1\mathbf{w}}{(s + b)^2 + \mathbf{w}^2} = \mathbf{a}_1 \frac{(s + b)}{(s + b)^2 + \mathbf{w}^2} + \mathbf{b}_1 \frac{\mathbf{w}}{(s + b)^2 + \mathbf{w}^2}$$

where $b = d_1 / 2$, $\mathbf{w} = \sqrt{d_0 - d_1^2 / 4}$

$$\mathbf{a}_1 = c_1, \quad \mathbf{b}_1 = (c_0 - \mathbf{a}_1b) / \mathbf{w}$$

- Inverse LT

$$f(t) = \mathbf{a}_1 e^{-bt} \cos \mathbf{w}t + \mathbf{b}_1 e^{-bt} \sin \mathbf{w}t$$

EXAMPLES ON INVERSE LAPLACE TRANSFORM

- $$F(s) = \frac{(s+5)}{s(s+1)(s+2)(s+3)} = \frac{A}{s} + \frac{B}{s+1} + \frac{C}{s+2} + \frac{D}{s+3} \quad (\text{distinct})$$

– Multiply each factor and insert the zero value

$$\left. \frac{(s+5)}{(s+1)(s+2)(s+3)} \right|_{s=0} = \left(A + s \frac{B}{s+1} + s \frac{C}{s+2} + s \frac{D}{s+3} \right) \Big|_{s=0} \Rightarrow A = 5/6$$

$$\left. \frac{(s+5)}{s(s+2)(s+3)} \right|_{s=-1} = \left(\frac{A(s+1)}{s} + B + \frac{C(s+1)}{s+2} + \frac{D(s+1)}{s+3} \right) \Big|_{s=-1} \Rightarrow B = -2$$

$$\left. \frac{(s+5)}{s(s+1)(s+3)} \right|_{s=-2} = \left(\frac{A(s+2)}{s} + \frac{B(s+2)}{s+1} + C + \frac{D(s+2)}{s+3} \right) \Big|_{s=-2} \Rightarrow C = 3/2$$

$$\left. \frac{(s+5)}{s(s+1)(s+2)} \right|_{s=-3} = \left(\frac{A(s+3)}{s} + \frac{B(s+3)}{s+1} + \frac{C(s+3)}{s+2} + D \right) \Big|_{s=-3} \Rightarrow D = -1/3$$

$$\therefore f(t) = \mathcal{L}^{-1}\{F(s)\} = \frac{5}{6} - 2e^{-t} + \frac{3}{2}e^{-2t} - \frac{1}{3}e^{-3t}$$

- $$F(s) = \frac{1}{(s+1)^3(s+2)} = \frac{As^2 + Bs + C}{(s+1)^3} + \frac{D}{(s+2)} \quad (\text{repeated})$$

$$1 = (As^2 + Bs + C)(s+2) + D(s+1)^3$$

$$= (A+D)s^3 + (2A+B+3D)s^2 + (2B+C+3D)s + (2C+D)$$

$$\therefore A = -D, \quad 2A + B + 3D = 0, \quad 2B + C + 3D = 0, \quad 2C + D = 1$$

$$\Rightarrow A = 1, \quad B = 1, \quad C = 1, \quad D = -1$$

- **Use of Heaviside expansion**
$$a_{r-i} = \frac{1}{i!} \frac{d^{(i)}}{ds^{(i)}} \left(\frac{N(s)}{D(s)} (s+p)^r \right) \Bigg|_{s=-p} \quad (i = 0, \dots, r-1)$$

$$\frac{s^2 + s + 1}{(s+1)^3} = \frac{\mathbf{a}_1}{(s+1)} + \frac{\mathbf{a}_2}{(s+1)^2} + \frac{\mathbf{a}_3}{(s+1)^3}$$

$$(i=0): \mathbf{a}_3 = (s^2 + s + 1) \Big|_{s=-1} = 1$$

$$(i=1): \mathbf{a}_2 = \frac{1}{1!} \frac{d}{ds} (s^2 + s + 1) \Big|_{s=-1} = -1$$

$$(i=2): \mathbf{a}_1 = \frac{1}{2!} \frac{d^2}{ds^2} (s^2 + s + 1) \Big|_{s=-1} = 1$$

$$\therefore f(t) = \mathcal{L}^{-1}\{F(s)\} = e^{-t} - te^{-t} + \frac{1}{2}t^2e^{-t} - e^{-2t}$$

- $$F(s) = \frac{(s+1)}{s^2(s^2+4s+5)} = \frac{A(s+2)+B}{(s+2)^2+1} + \frac{Cs+D}{s^2} \quad (\text{complex})$$

$$s+1 = A(s+2)s^2 + Bs^2 + (Cs+D)(s^2+4s+5)$$

$$= (A+C)s^3 + (2A+B+4C+D)s^2 + (5C+4D)s + 5D$$

$$\therefore A = -C, \quad 2A+B+4C+D=0, \quad 5C+4D=1, \quad 5D=1$$

$$\Rightarrow A = -1/25, \quad B = -7/25, \quad C = 1/25, \quad D = 1/5$$

$$\frac{A(s+2)+B}{(s+2)^2+1} = -\frac{1}{25} \frac{(s+2)}{(s+2)^2+1} - \frac{7}{25} \frac{B}{(s+2)^2+1}$$

$$\frac{Cs+D}{s^2} = \frac{1}{25} \frac{1}{s} + \frac{1}{5} \frac{1}{s^2}$$

$$\therefore f(t) = \mathcal{L}^{-1}\{F(s)\} = -\frac{1}{25} e^{-2t} \cos t - \frac{7}{25} e^{-2t} \sin t + \frac{1}{25} + \frac{1}{5} t$$

- $$F(s) = \frac{1 + e^{-2s}}{(4s + 1)(3s + 1)} = \left(\frac{A}{4s + 1} + \frac{B}{3s + 1} \right) (1 + e^{-2s}) \quad (\text{Time delay})$$

$$A = 1/(3s + 1)|_{s=-1/4} = 4, \quad B = 1/(4s + 1)|_{s=-1/3} = -3$$

$$\begin{aligned} \therefore f(t) &= \mathcal{L}^{-1}\{F(s)\} = \mathcal{L}^{-1}\left\{\frac{4}{4s + 1} - \frac{3}{3s + 1}\right\} + \mathcal{L}^{-1}\left\{\frac{4e^{-2s}}{4s + 1} - \frac{3e^{-2s}}{3s + 1}\right\} \\ &= e^{-t/4} - e^{-t/3} + \left(e^{-(t-2)/4} - e^{-(t-2)/3}\right)S(t-2) \end{aligned}$$



**It is a brain teaser!!!
But you have to live with it.**

**Hang on!!!
You are half way there.**



SOLVING ODE BY LAPLACE TRANSFORM

- **Procedure**

1. **Given linear ODE with initial condition,**
2. **Take Laplace transform and solve for output**
3. **Inverse Laplace transform**

- **Example:** Solve for $5\frac{dy}{dt} + 4y = 2; y(0) = 1$

$$\mathcal{L}\left\{5\frac{dy}{dt}\right\} + \mathcal{L}\{4y\} = \mathcal{L}\{2\} \Rightarrow 5(sY(s) - y(0)) + 4Y(s) = \frac{2}{s}$$

$$(5s + 4)Y(s) = \frac{2}{s} + 5 \Rightarrow Y(s) = \frac{5s + 2}{s(5s + 4)}$$

$$\therefore y(t) = \mathcal{L}^{-1}\{Y(s)\} = \mathcal{L}^{-1}\left\{\frac{0.5}{s} + \frac{2.5}{5s + 4}\right\} = 0.5 + 0.5e^{-0.8t}$$

TRANSFER FUNCTION (1)

- **Definition**

- An algebraic expression for the dynamic relation between the input and output of the process model

$$5 \frac{dy}{dt} + 4y = u; y(0) = 1$$

$$\text{Let } \tilde{y} = y - 1 \text{ and } \tilde{u} = u - 4$$

$$(5s + 4)\tilde{Y}(s) = \tilde{U}(s) \Rightarrow \frac{\tilde{Y}(s)}{\tilde{U}(s)} = \frac{1}{5s + 4} = \frac{0.25}{1.25s + 1} = G(s)$$



- **How to find transfer function**

1. Find the equilibrium point
2. If the system is nonlinear, then linearize around equil. point
3. Introduce deviation variables
4. Take Laplace transform and solve for output
5. Do the Inverse Laplace transform and recover the original variables from deviation variables

TRANSFER FUNCTION (2)

- **Benefits**

- **Once TF is known, the output response to various given inputs can be obtained easily.**

$$y(t) = \mathcal{L}^{-1}\{Y(s)\} = \mathcal{L}^{-1}\{G(s)U(s)\} \neq \mathcal{L}^{-1}\{G(s)\} \mathcal{L}^{-1}\{U(s)\}$$

- **Interconnected system can be analyzed easily.**

- **By block diagram algebra**

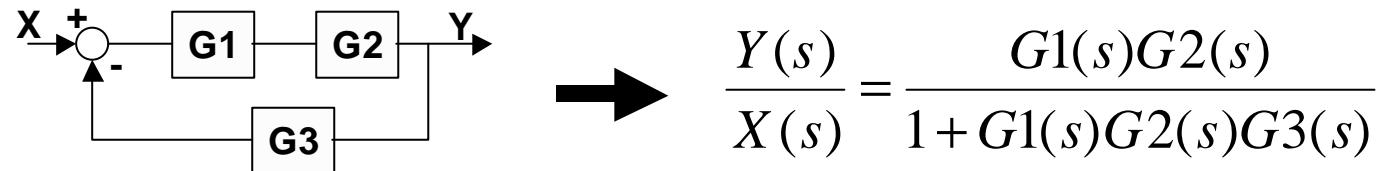

- **Easy to analyze the qualitative behavior of a process, such as stability, speed of response, oscillation, etc.**

- **By inspecting “Poles” and “Zeros”**
- **Poles: all s 's satisfying $D(s)=0$**
- **Zeros: all s 's satisfying $N(s)=0$**

TRANSFER FUNCTION (3)

- **Steady-state Gain: The ratio between ultimate changes in input and output**

$$\text{Gain}=K = \frac{\Delta \text{output}}{\Delta \text{input}} = \frac{(y(\infty) - y(0))}{(u(\infty) - u(0))}$$

- For a unit step change in input, the gain is the change in output
- Gain may not be definable: for example, integrating processes and processes with sustaining oscillation in output
- From the final value theorem, unit step change in input with zero initial condition gives

$$K = \frac{y(\infty)}{1} = \lim_{s \rightarrow 0} sY(s) = \lim_{s \rightarrow 0} sG(s) \frac{1}{s} = \lim_{s \rightarrow 0} G(s)$$

- The transfer function itself is an impulse response of the system $Y(s) = G(s)U(s) = G(s)\mathcal{L}\{d(t)\} = G(s)$

EXAMPLE

- **Horizontal cylindrical storage tank (Ex4.7)**

$$\frac{dm}{dt} = r \frac{dV}{dt} = r q_i - r q$$

$$V(h) = \int_0^h L w_i(\tilde{h}) d\tilde{h} \Rightarrow \frac{dV}{dt} = L w_i(h) \frac{dh}{dt}$$

$$w_i(h) / 2 = \sqrt{R^2 + (R-h)^2} = \sqrt{(2R-h)h}$$

$$w_i L \frac{dh}{dt} = q_i - q \Rightarrow \frac{dh}{dt} = \frac{1}{2L\sqrt{(D-h)h}} (q_i - q) \quad (\text{Nonlinear ODE})$$

- **Equilibrium point:** $(\bar{q}_i, \bar{q}, \bar{h}) \quad 0 = (\bar{q}_i - \bar{q}) / (2L\sqrt{(D-\bar{h})\bar{h}})$
(if $\bar{q}_i = \bar{q}$, \bar{h} can be any value in $0 \leq \bar{h} \leq D$.)

- **Linearization:**

$$\frac{dh}{dt} = f(h, q_i, q) = \left. \frac{\partial f}{\partial h} \right|_{(\bar{h}, \bar{q}_i, \bar{q})} (h - \bar{h}) + \left. \frac{\partial f}{\partial q_i} \right|_{(\bar{h}, \bar{q}_i, \bar{q})} (q_i - \bar{q}_i) + \left. \frac{\partial f}{\partial q} \right|_{(\bar{h}, \bar{q}_i, \bar{q})} (q - \bar{q})$$

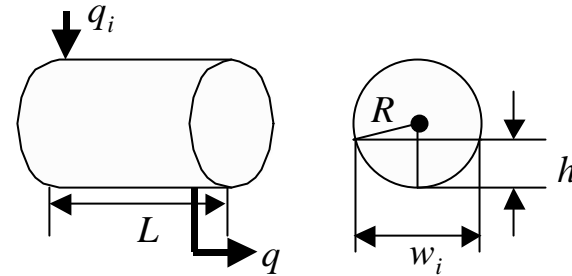

$$\left. \frac{\partial f}{\partial h} \right|_{(\bar{h}, \bar{q}_i, \bar{q})} = (\bar{q}_i - \bar{q}) \frac{\partial}{\partial h} \frac{-1}{2L\sqrt{(D-h)h}} = 0 \quad (\because \bar{q}_i = \bar{q})$$

$$\left. \frac{\partial f}{\partial q} \right|_{(\bar{h}, \bar{q}_i, \bar{q})} = \frac{-1}{2L\sqrt{(D-h)h}}, \quad \left. \frac{\partial f}{\partial q_i} \right|_{(\bar{h}, \bar{q}_i, \bar{q})} = \frac{1}{2L\sqrt{(D-h)h}}$$

Let this term be k

$$s\tilde{H}(s) = k\tilde{Q}_i(s) - k\tilde{Q}(s)$$

- **Transfer function between $\tilde{H}(s)$ and $\tilde{Q}(s)$: $-\frac{k}{s}$ (integrating)**
- **Transfer function between $\tilde{H}(s)$ and $\tilde{Q}_i(s)$: $\frac{k}{s}$ (integrating)**
- **If \bar{h} is near 0 or D , k becomes very large and \bar{h} is around $\bar{h}/2$, k becomes minimum.**

ⓘ The model could be quite different depending on the operating condition used for the linearization.

ⓘ The best suitable range for the linearization in this case is around $\bar{h}/2$. (less change in gain)

ⓘ Linearized model would be valid in very narrow range near 0

PROPERTIES OF TRANSFER FUNCTION

- **Additive property**

$$\begin{aligned} Y(s) &= Y_1(s) + Y_2(s) \\ &= G_1(s)X_1(s) + G_2(s)X_2(s) \end{aligned}$$

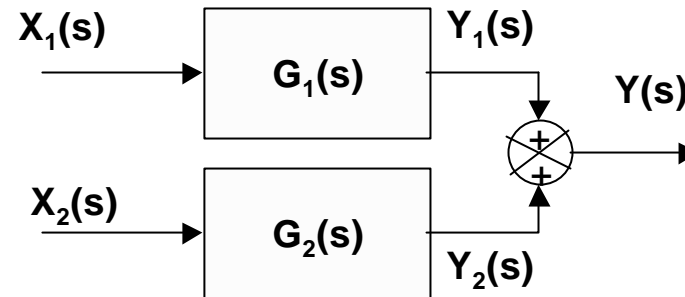

- **Multiplicative property**

$$\begin{aligned} X_3(s) &= G_2(s)X_2(s) \\ &= G_2(s)[G_1(s)X_1(s)] = G_2(s)G_1(s)X_1(s) \end{aligned}$$

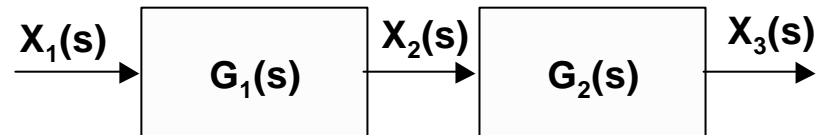

- **Physical realizability**

- In a transfer function, the order of numerator(m) is greater than that of denominator(n): called “physically unrealizable”
- The order of derivative for the input is higher than that of output. (requires future input values for current output)

EXAMPLES ON TWO TANK SYSTEM

- **Two tanks in series (Ex3.7)**

- No reaction

$$V_1 \frac{dc_1}{dt} + qc_1 = qc_i$$

$$V_2 \frac{dc_2}{dt} + qc_2 = qc_1$$

- **Initial condition:** $c_1(0) = c_2(0) = 1 \text{ kg mol/m}^3$ (Use deviation var.)

- **Parameters:** $V_1/q = 2 \text{ min.}$, $V_2/q = 1.5 \text{ min.}$

- **Transfer functions**

$$\frac{\tilde{C}_1(s)}{\tilde{C}_i(s)} = \frac{1}{(V_1/q)s + 1}$$

$$\frac{\tilde{C}_2(s)}{\tilde{C}_1(s)} = \frac{1}{(V_2/q)s + 1}$$

$$\frac{\tilde{C}_2(s)}{\tilde{C}_i(s)} = \frac{\tilde{C}_2(s)}{\tilde{C}_1(s)} \frac{\tilde{C}_1(s)}{\tilde{C}_i(s)} = \frac{1}{((V_2/q)s + 1)((V_1/q)s + 1)}$$

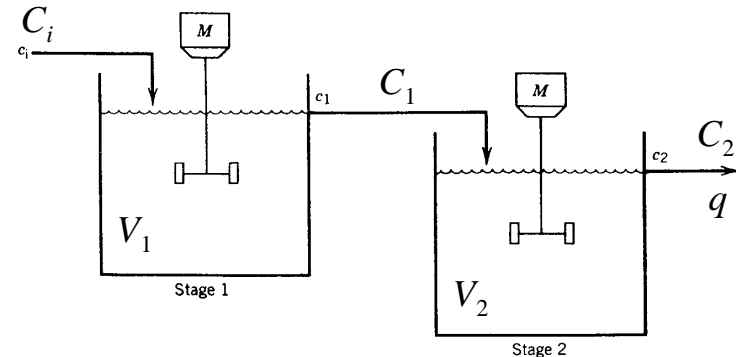
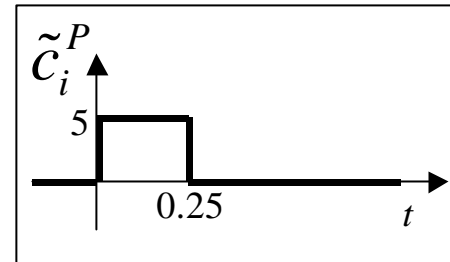

Figure 3.4. Two-stage stirred-tank reactor system.

- **Pulse input**

$$\tilde{C}_i^P(s) = \frac{5}{s} (1 - e^{-0.25s})$$



- **Equivalent impulse input**

$$\tilde{C}_i^d(s) = \mathcal{L}\{(5 \times 0.15)d(t)\} = 1.25$$

- **Pulse response vs. Impulse response**

$$\tilde{C}_1^P(s) = \frac{1}{2s+1} \tilde{C}_i^P(s) = \frac{5}{s(2s+1)} (1 - e^{-0.25s})$$

$$= \left(\frac{5}{s} - \frac{10}{2s+1} \right) (1 - e^{-0.25s})$$

$$\Rightarrow \tilde{c}_1^P(t) = 5(1 - e^{-t/2}) - 5(1 - e^{-(t-0.25)/2})S(t-0.25)$$

$$\tilde{C}_1^d(s) = \frac{1}{2s+1} \tilde{C}_i^d(s) = \frac{1.25}{(2s+1)}$$

$$\Rightarrow \tilde{c}_1^d = 0.625e^{-t/2}$$

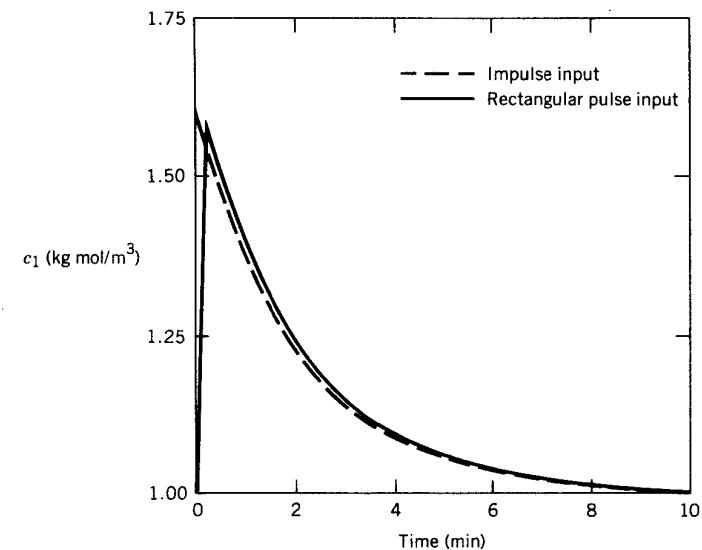

Figure 3.6. Reactor Stage 1 response.

$$\tilde{C}_2^P(s) = \frac{1}{(2s+1)(1.5s+1)} \tilde{C}_i^P(s) = \frac{5}{s(2s+1)(1.5s+1)} (1 - e^{-0.25s})$$

$$= \left(\frac{5}{s} - \frac{40}{2s+1} + \frac{22.5}{1.5s+1} \right) (1 - e^{-0.25s})$$

$$\Rightarrow \tilde{c}_2^P(t) = (5 - 20e^{-t/2} + 15e^{-t/1.5}) - (5 - 20e^{-(t-0.25)/2} + 15e^{-(t-0.25)/1.5}) S(t - 0.25)$$

$$\tilde{C}_2^d(s) = \frac{1}{(2s+1)(1.5s+1)} \tilde{C}_i^d(s)$$

$$= \frac{1.25}{(2s+1)(1.5s+1)}$$

$$= \frac{5}{2s+1} - \frac{3.75}{1.5s+1}$$

$$\Rightarrow \tilde{c}_2^d = 2.5e^{-t/2} - 2.5e^{-t/1.5}$$

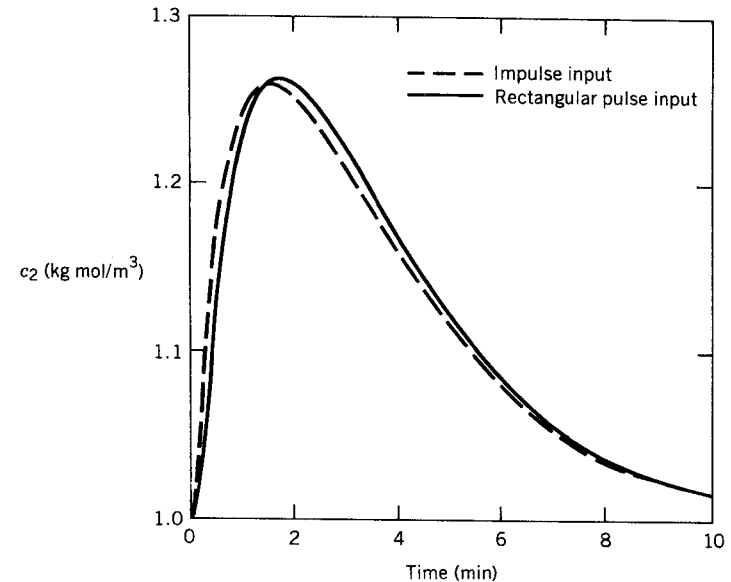

Figure 3.7. Reactor Stage 2 response.